



Inanç
Cooling system

soğutmada
kalıcı çözümler

inancteknik.com.tr

MİSYON

Kuruluşumuzdan bugüne; çözümlerimiz, güvenilirliğimiz ve yüksek iş ahlakımız ile müşterilerin ve çalışanların ilk tercihi olmakla beraber yüksek standartlı ve kaliteli hizmet vererek müşteri memnuniyetini en üst düzeye çıkarmak. Bilgi çağının getirdiği yeni kaçınılmaz gerçekler doğrultusunda çözüm ortağı kimliği ile işletmelerin ihtiyaçlarına çözüm odaklı yaklaşarak, çalışma ve çabalarımızı sürdürmeye devam ederken geride kimseyi bırakmamak. **İnanç Cooling Systems** ailesi olarak görerek bakmak ve anlayarak çözmek için her zaman çalışanlarımız ve müşterilerimizin yanında olacağız





VİZYON

İçinde bulunduğu sektöre liderlik eden, çalışanlarına ilham veren, mükemmellik ile katma değer yaratan seçkin bir dolap firması olmanın yanı sıra ürün ve hizmetlerimizi sürekli olarak geliştirerek en yüksek kaliteyi ve eksiksiz müşteri memnuniyetini sunmaya odaklanıyoruz. Asıl amacımız hizmetlerimizin sürekliliğini sağlamak ve yapmış olduğumuz yatırımlar ile Ülke ekonomisine katkı sağlamaktır. Bunun yanı sıra istihdam yaratmak ve Kuruluş amacından sapmadan istikrarlı bir şekilde ilerlemek ilkelerimizdendir.







DIŐTAN MOTORLU | REMOTE

ŐARKÜTERİ COUNTERS	1-2
SYDNEY CG	3-4
SYDNEY FG	5-6
SYDNEY AFG	7-8
SYDNEY SS. CG	9-10
SYDNEY SS. FG	11-12
SALTA FG	13-14
SÜTLÜK MULTIDECKS	15-16
MELBOURNE	17-18
MELBOURNE DGD	19-20
MELBOURNE D-SGD	21-22
MELBOURNE OGD	23-24
MELBOURNE HB	25-26
MELBOURNE HB DGD	27-28
MELBOURNE HB D-SGD	29-30
MELBOURNE HB D-OGD	31-32
MELBOURNE WB	33-34
MELBOURNE RB	35-36
MELBOURNE FV	37-38
DARWIN	39-40
MARLO	41-42
SÜTLÜK MULTIDECKS	43-44
MARBELLA	45-46
DERİN DONDURUCU CABINETS AND MIX CABINETS MANAMA	
MANAMA	47-48

İÇTEN MOTORLU | PLUG-IN

ŐARKÜTERİ COUNTERS	
SPARTA CG -FG	49-50
SPARTA AFG	51-52
SPARTA SS.CG-FG	53-54
STOW FG	55-56
HAWAII	57-58
ŐARKÜTERİ COUNTERS	59-60
SÜTLÜK MULTIDECKS	
MANDURAH	61-62
MANDURAH DGD	63-64
MANDURAH FV	65-66
DRY AGED	67-68
KISA SÜTLÜK SV - MULTIDECKS	
MACON	69-70
PROMOSYON PROMOTION	
BRISBANE	71-72
BRISBANE NC. O-SGD	73-74
SOĐUK HAVA DEPOLARI COLD ROOMS	75
SOĐUTMA SİSTEMLERİ COOLING SYSTEMS	75

ŞARKÜTERİ | COUNTERS



DIŐTAN MOTORLU | **REMOTE**



SYDNEY CG

DIŐTAN MOTORLU | REMOTE

SYDNEY AK.CG



SYDNEY BA.CG



modules 0.938 1.25 1.875 2.500 2.812 3.124 3.750

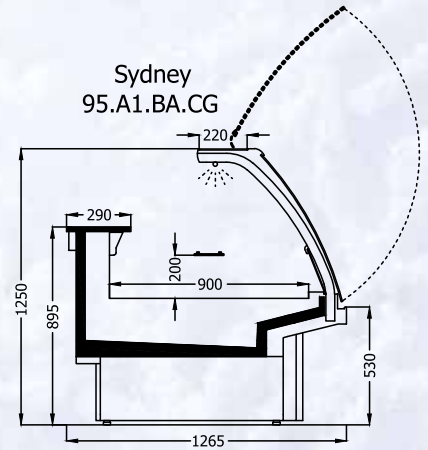
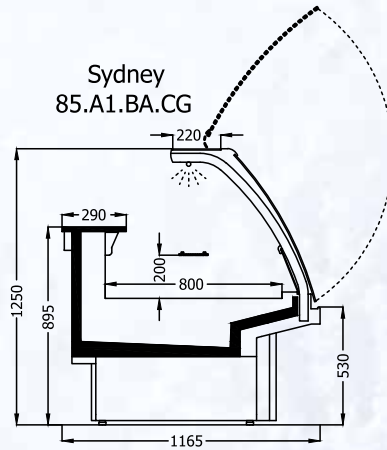
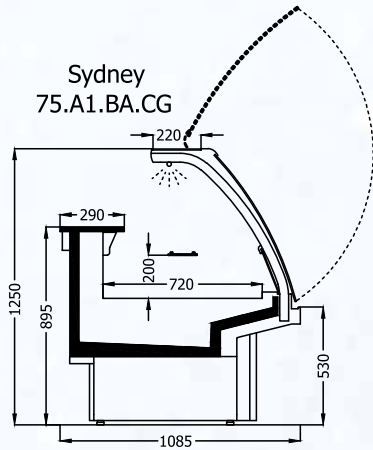
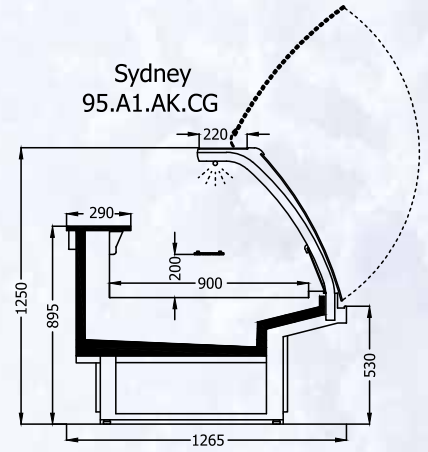
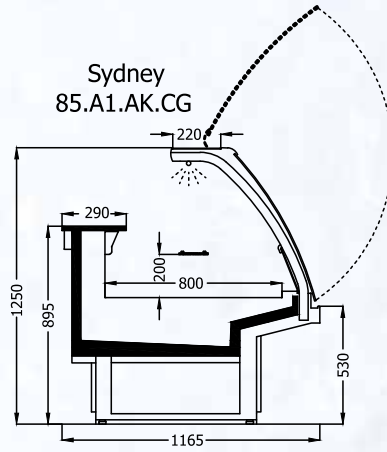
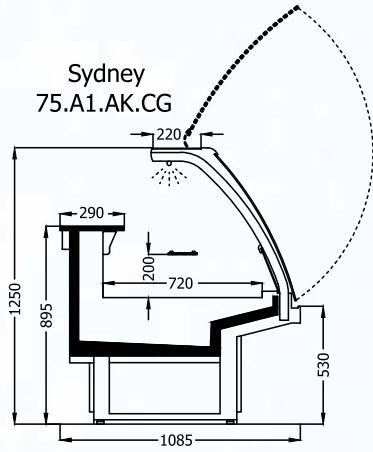

Sydney 85.A1 ICC 90°

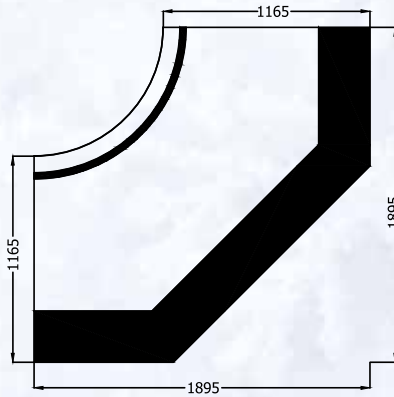

Sydney 95.A1 ICC 90°

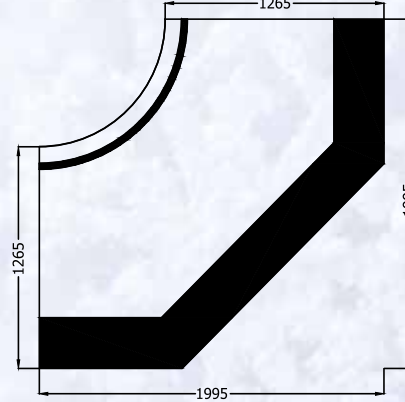

Sydney 85.A1 OCC 90°

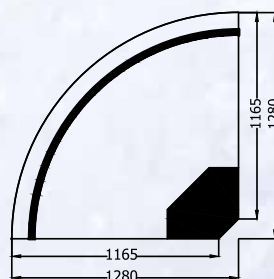

Sydney 95.A1 OCC 90°

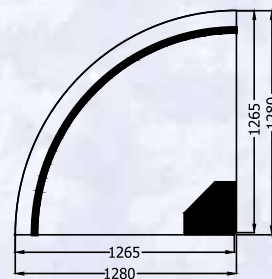

SYDNEY FG

DIŐTAN MOTORLU | REMOTE

SYDNEY AK.FG



SYDNEY BA.FG



modules 0.938 1.25 1.875 2.500 2.812 3.124 3.750

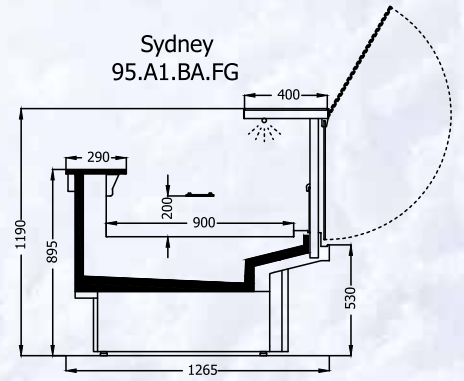
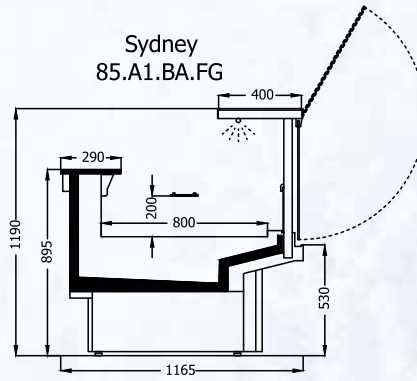
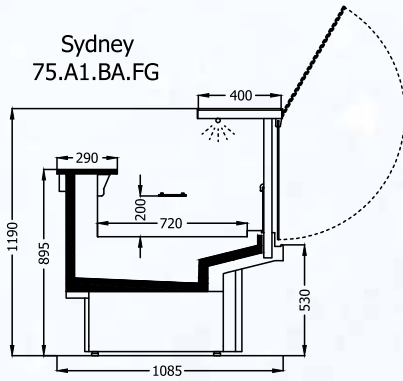
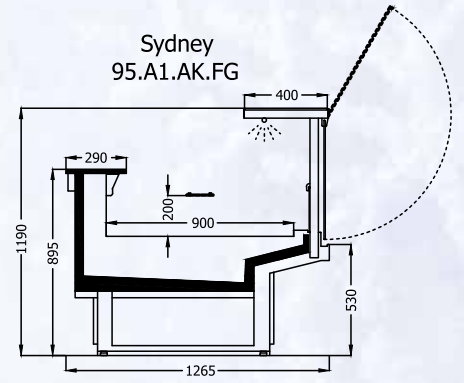
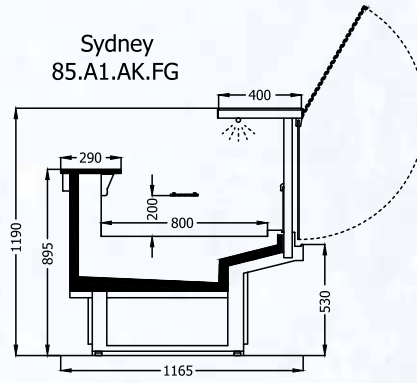
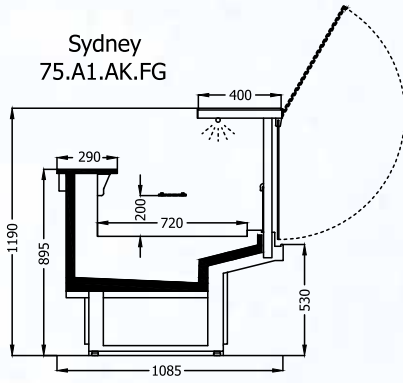

Sydney 85.A1 ICC 90°

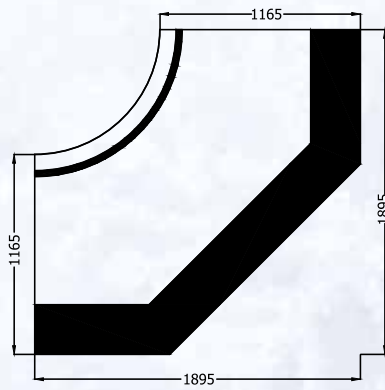

Sydney 95.A1 ICC 90°

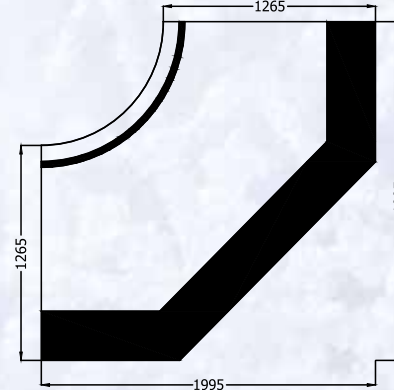

Sydney 85.A1 OCC 90°

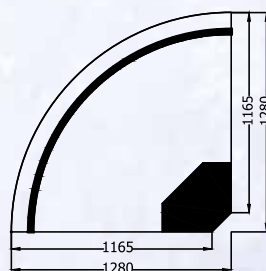

Sydney 95.A1 OCC 90°

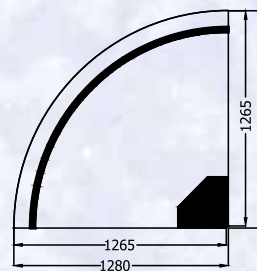

SYDNEY AFG

DIŐTAN MOTORLU | REMOTE

SYDNEY AK.AFG



SYDNEY BA.AFG



modules 0.938 1.25 1.875 2.500 2.812 3.124 3.750

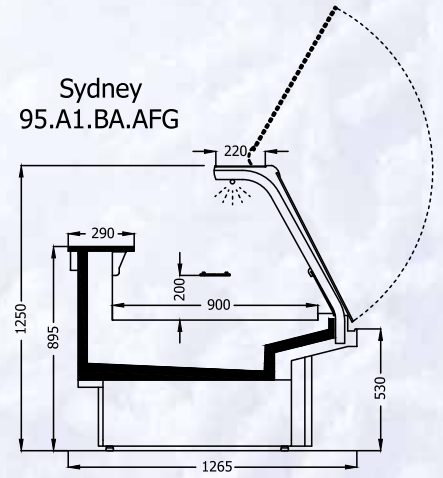
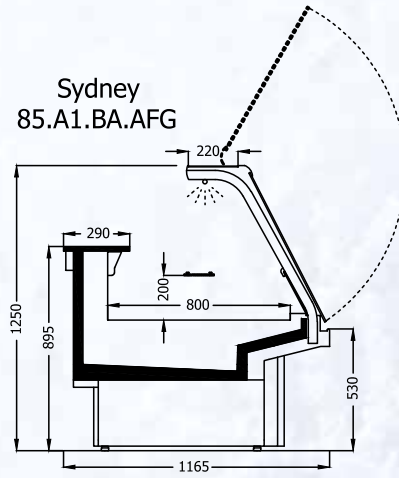
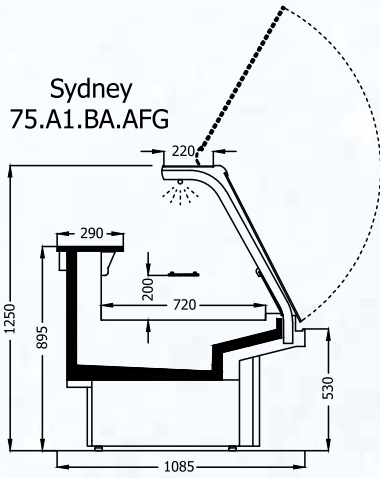
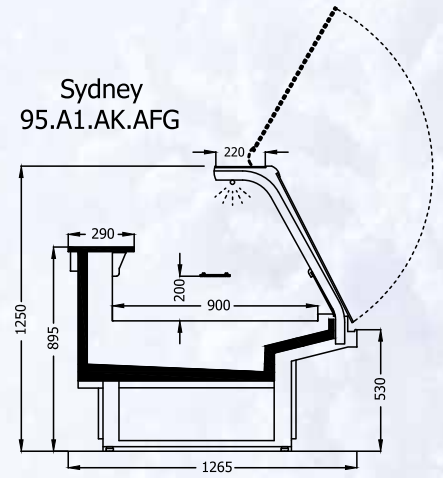
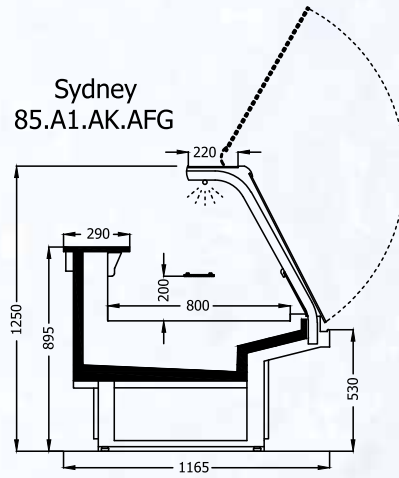
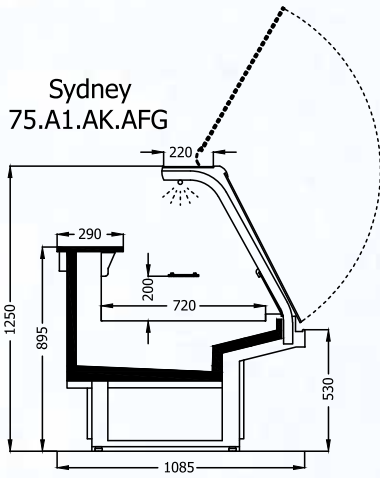

Sydney 85.A1 ICC 90°

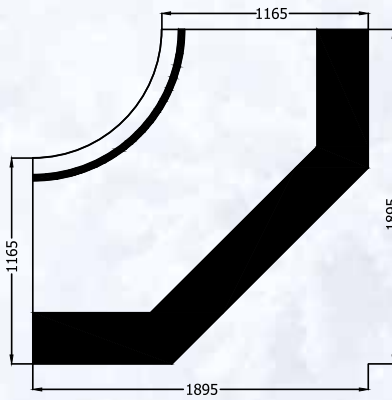

Sydney 95.A1 ICC 90°

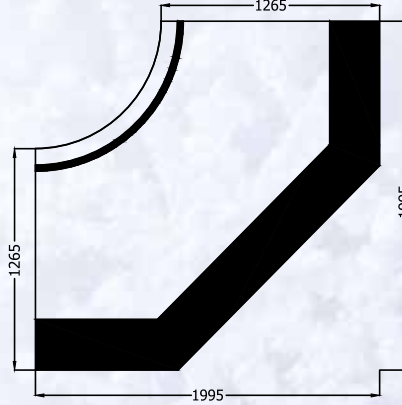

Sydney 85.A1 OCC 90°

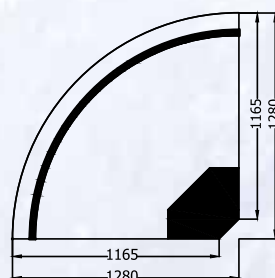

Sydney 95.A1 OCC 90°

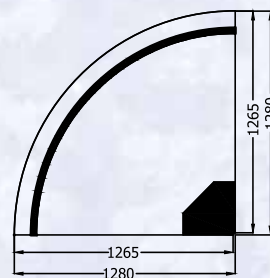

SYDNEY SS.CG

DIŐTAN MOTORLU | REMOTE

SYDNEY AK.SS.CG

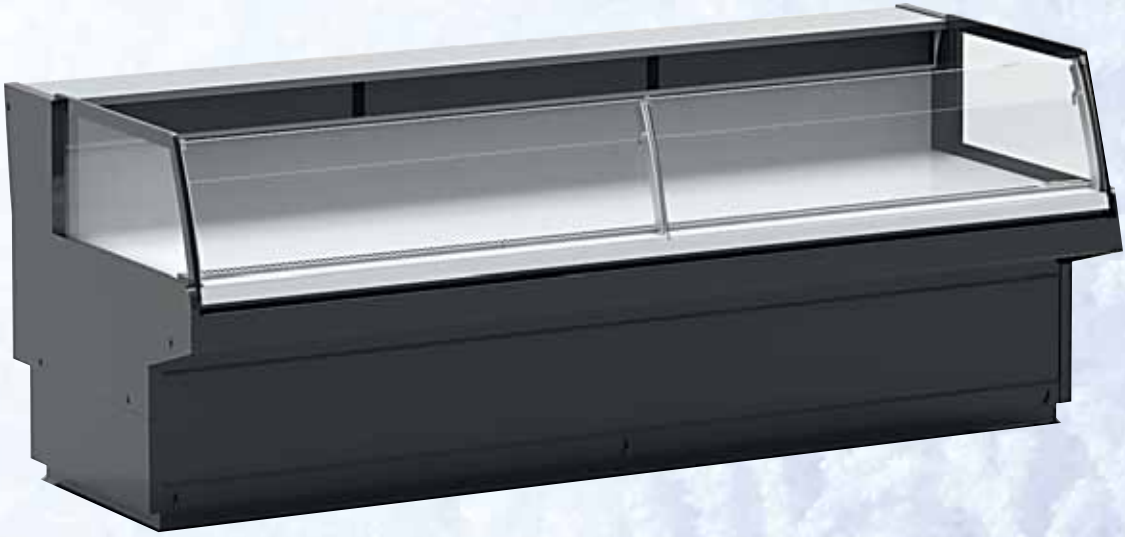

SYDNEY BA.SS.CG



modules 0.938 1.25 1.875 2.500 2.812 3.124 3.750

Sydney
75.A1.AK.SS.CG

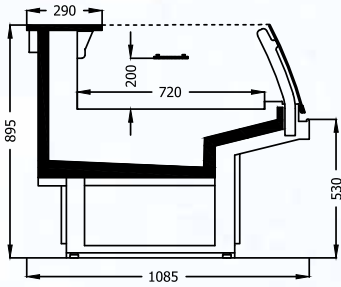

Sydney
85.A1.AK.SS.CG

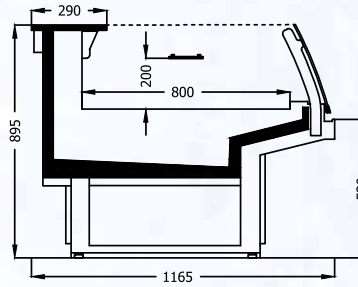

Sydney
95.A1.AK.SS.CG

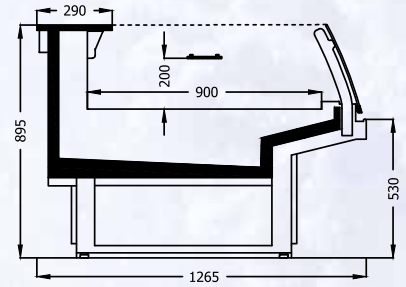

Sydney
75.A1.BA.SS.CG

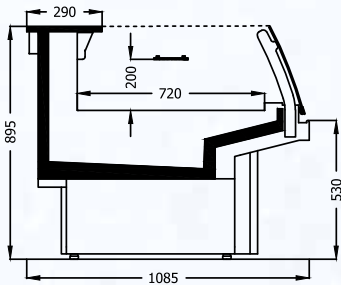

Sydney
85.A1.BA.SS.CG

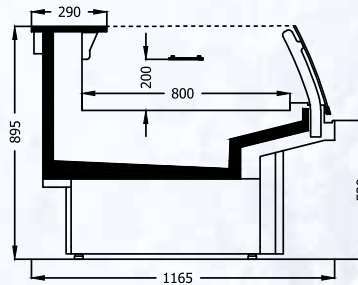

Sydney
95.A1.BA.SS.CG

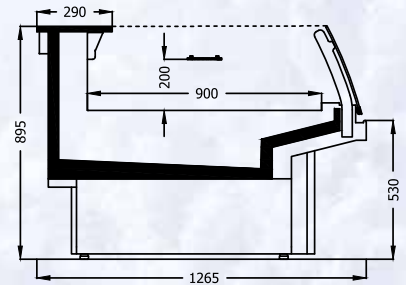

Sydney 85.A1 ICC 90°

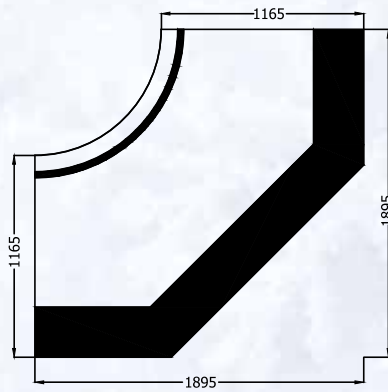

Sydney 95.A1 ICC 90°

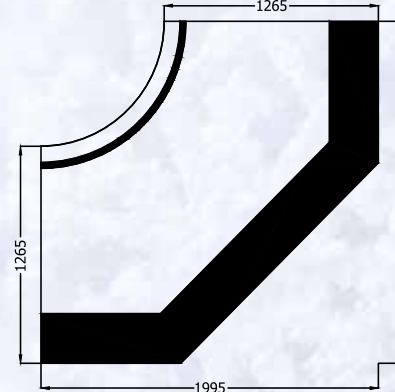

Sydney 85.A1 OCC 90°

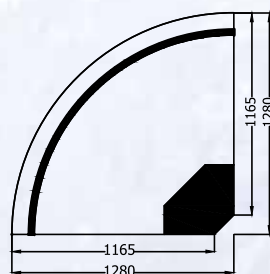

Sydney 95.A1 OCC 90°

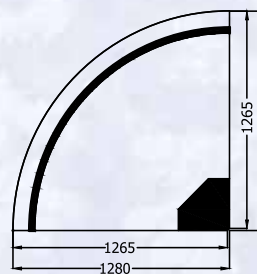

SYDNEY SS.FG

DIŐTAN MOTORLU | REMOTE

SYDNEY AK.SS.FG



SYDNEY BA.SS.FG



modules 0.938 1.25 1.875 2.500 2.812 3.124 3.750

Sydney
75.A1.AK.SS.FG

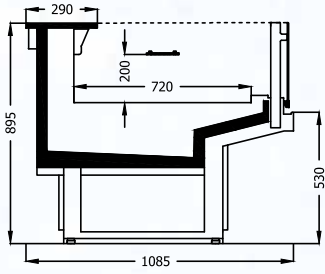

Sydney
85.A1.AK.SS.FG

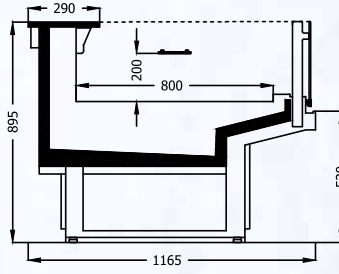

Sydney
95.A1.AK.SS.FG

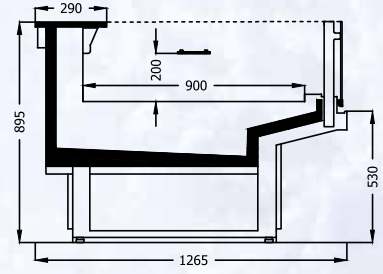

Sydney
75.A1.BA.SS.FG

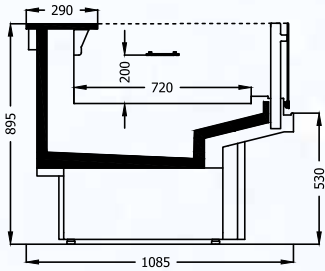

Sydney
85.A1.BA.SS.FG

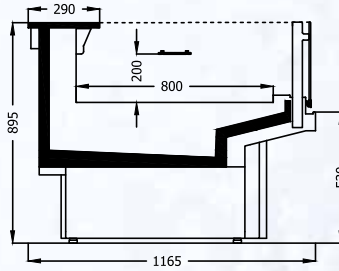

Sydney
95.A1.BA.SS.FG

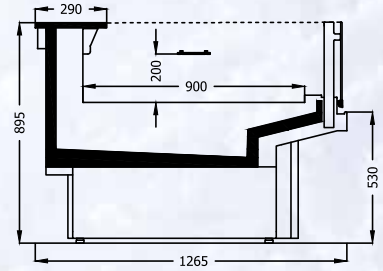

Sydney 85.A1 ICC 90°

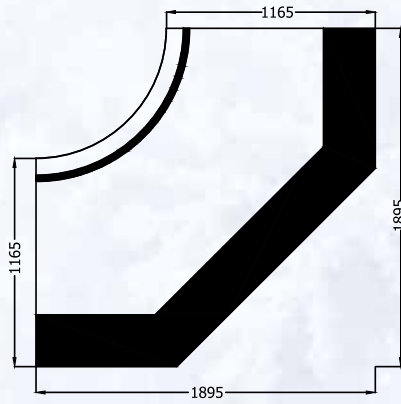

Sydney 95.A1 ICC 90°

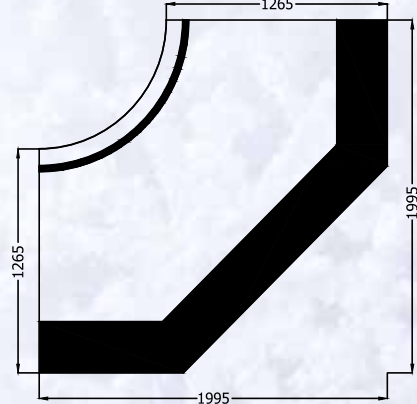

Sydney 85.A1 OCC 90°

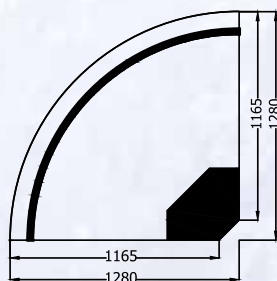

Sydney 95.A1 OCC 90°

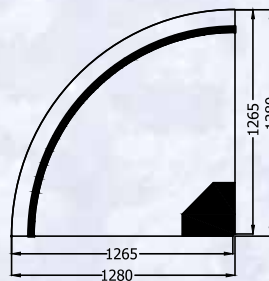

SALTA FG

DIŞTAN MOTORLU | REMOTE

SALTA AK.FG

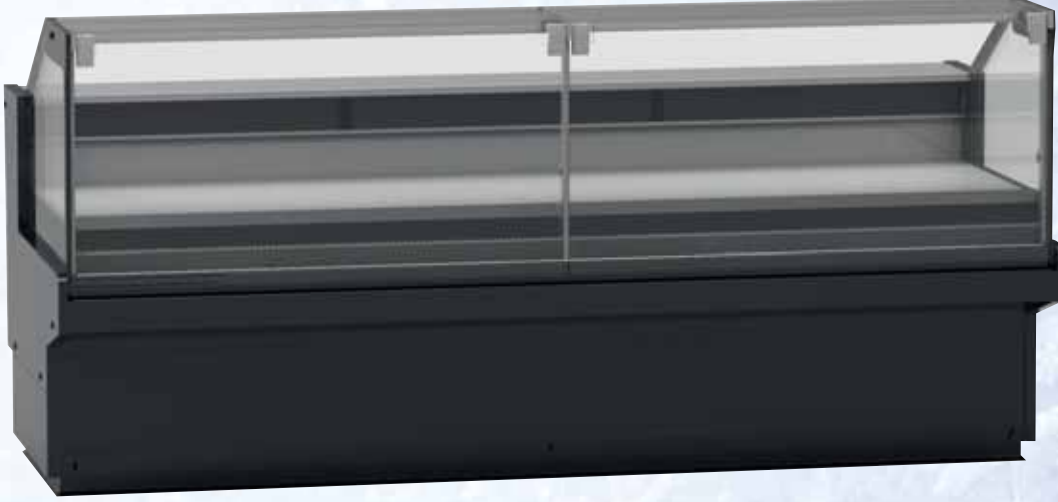

SALTA BA.FG



modules 0.938 1.25 1.875 2.500 2.812 3.124 3.750

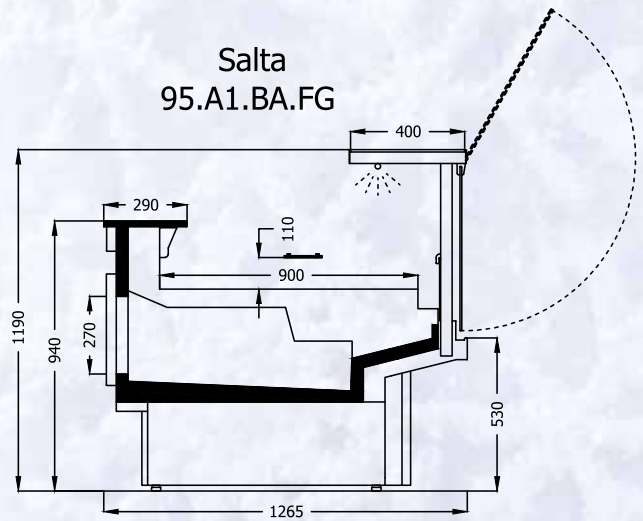
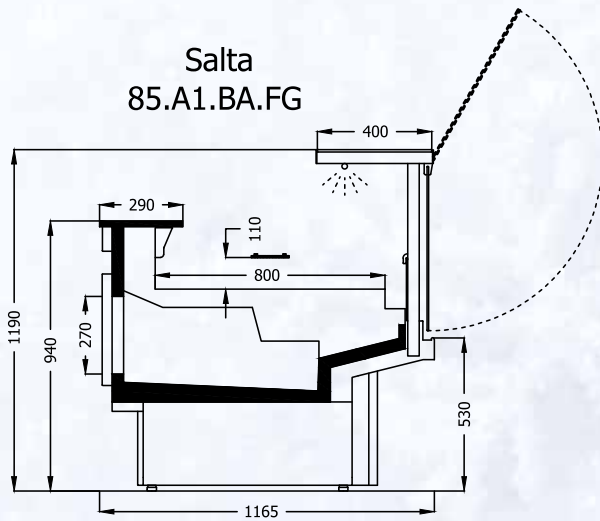
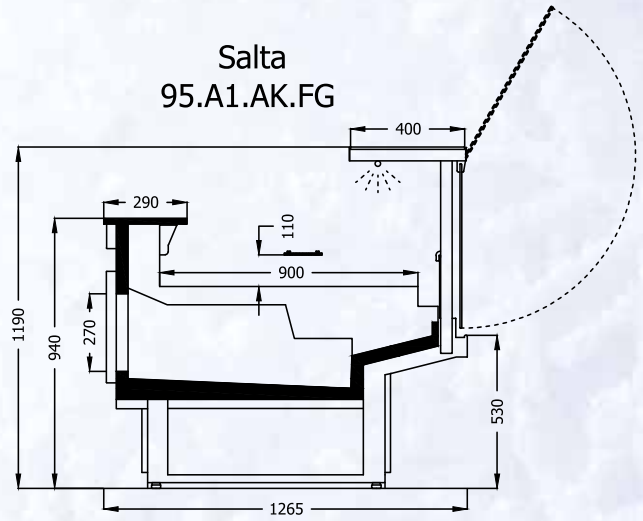
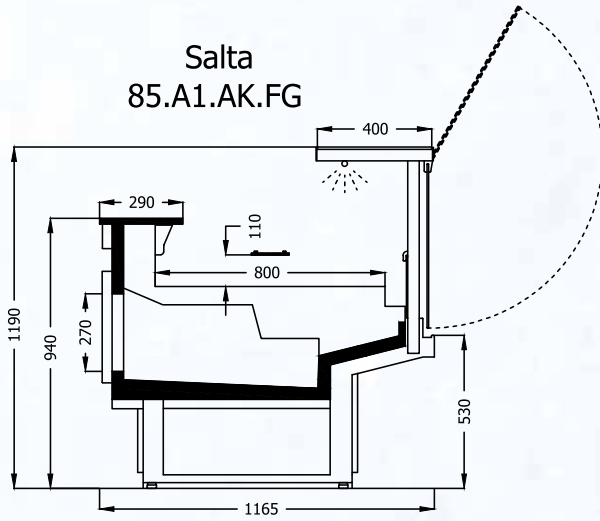

SÜTLÜK | MULTI DECKS



DIŐTAN MOTORLU | REMOTE



MELBOURNE

DIŐTAN MOTORLU | REMOTE

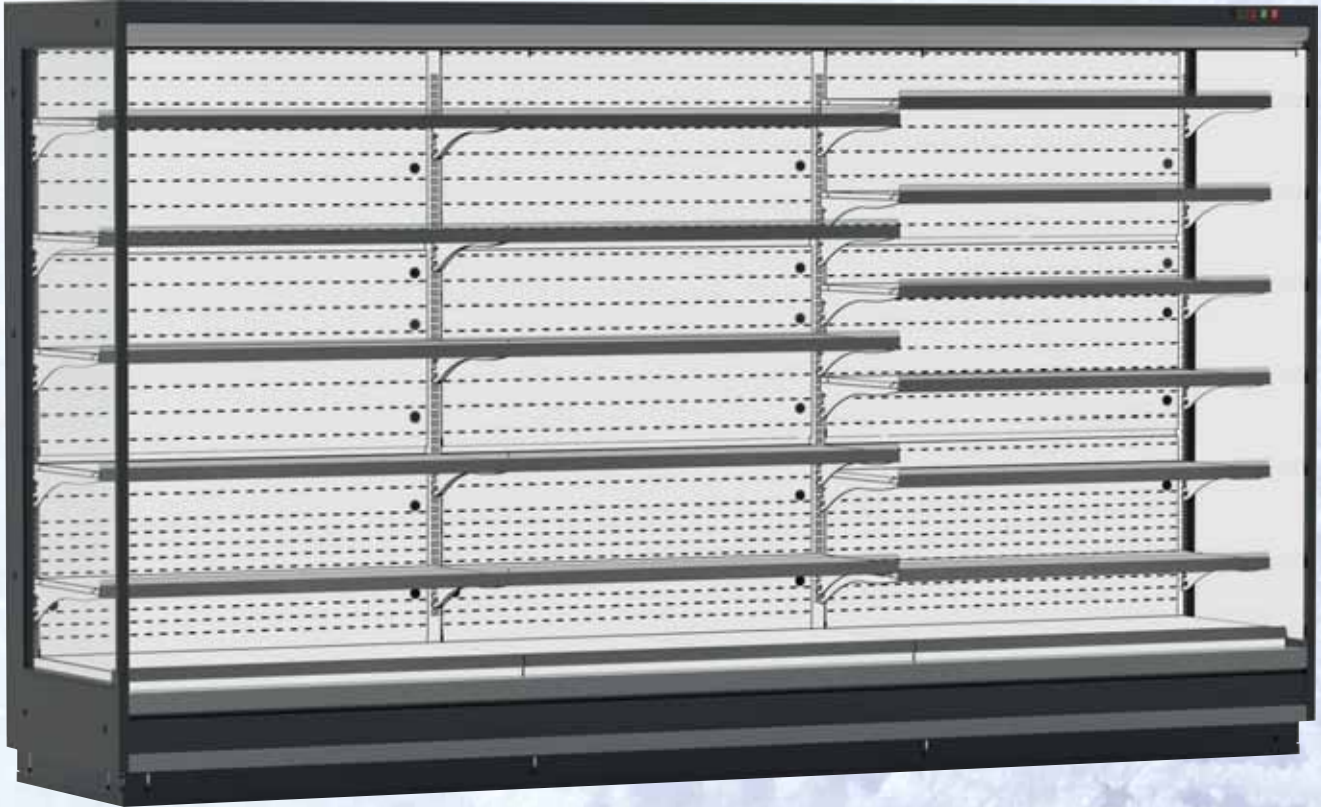

modules 0.938 1.25 1.875 2.500 2.812 3.124 3.750

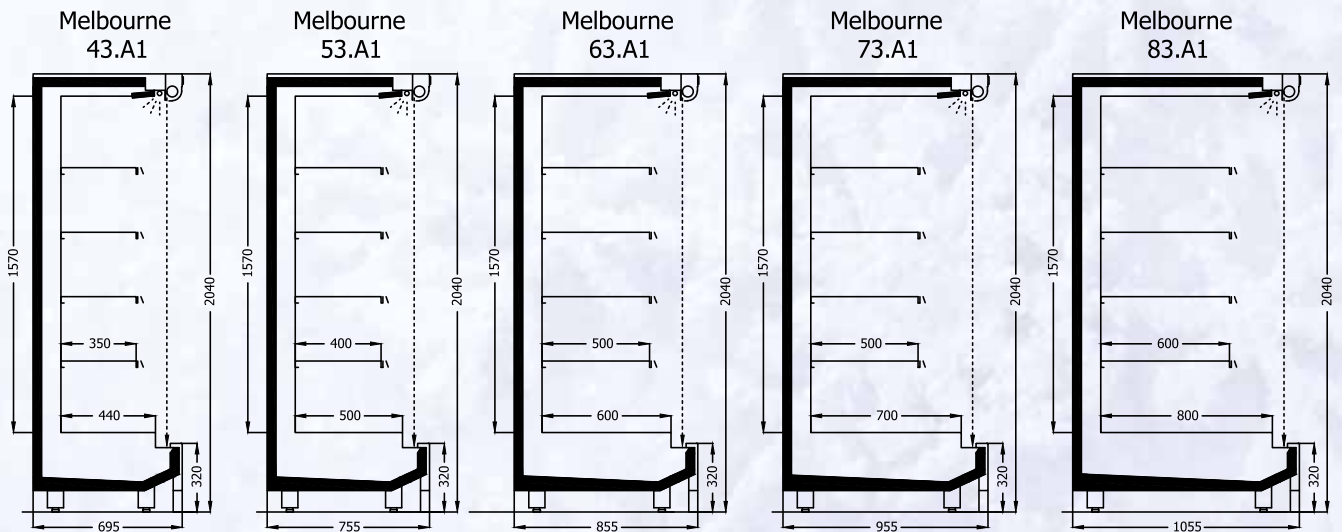
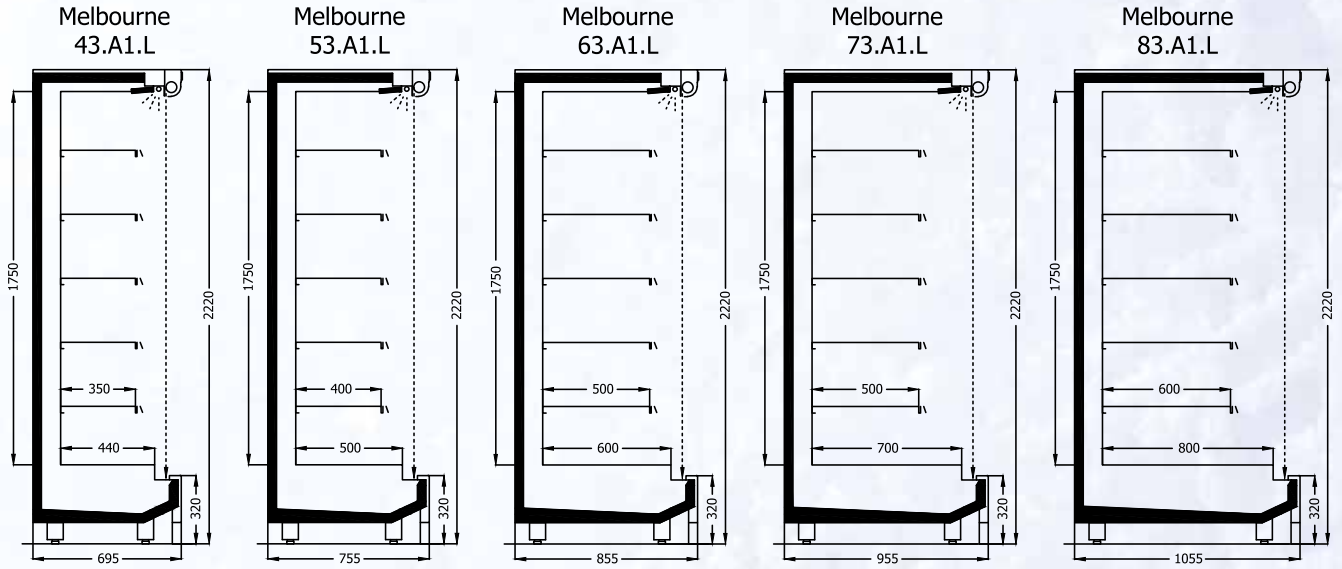

MELBOURNE DGD

DIŐTAN MOTORLU | REMOTE

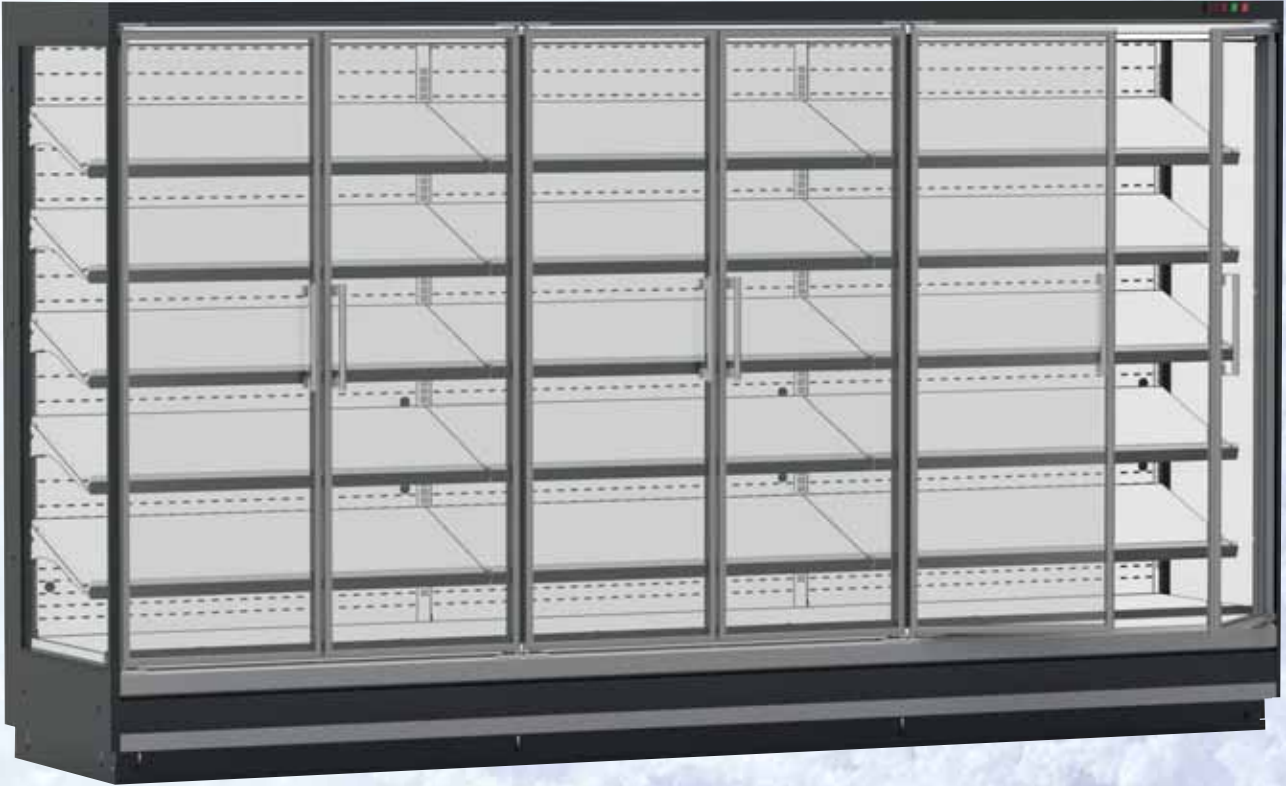

modules 0.938 1.25 1.875 2.500 2.812 3.124 3.750

Melbourne
43.A1.L.DGD

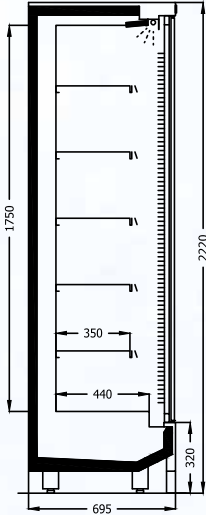

Melbourne
53.A1.L.DGD

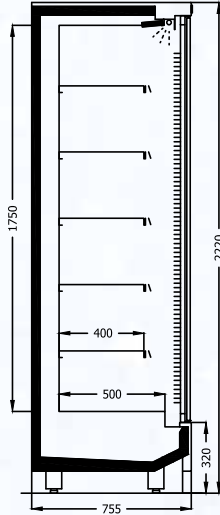

Melbourne
63.A1.L.DGD

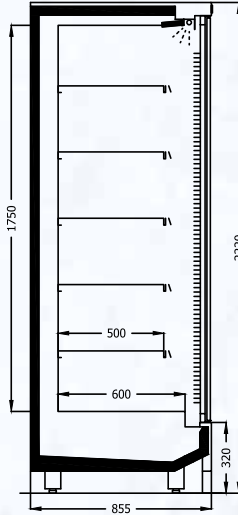

Melbourne
73.A1.L.DGD

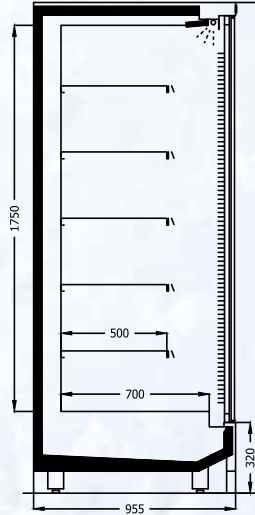

Melbourne
83.A1.L.DGD

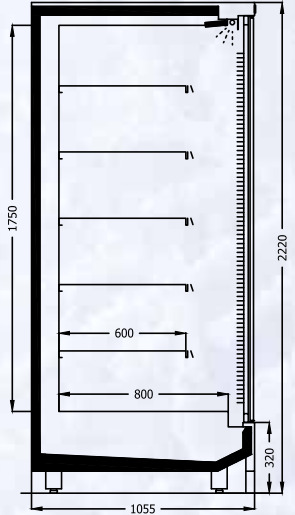

Melbourne
43.A1.DGD

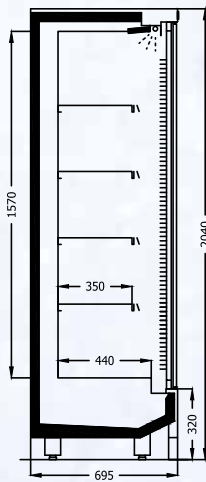

Melbourne
53.A1.DGD

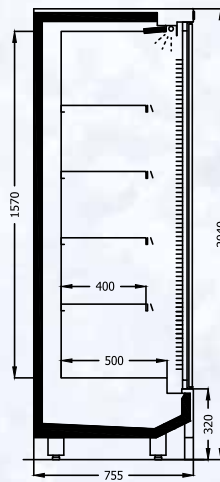

Melbourne
63.A1.DGD

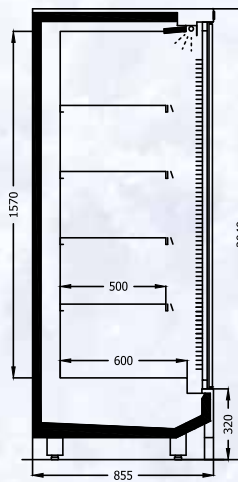

Melbourne
73.A1.DGD

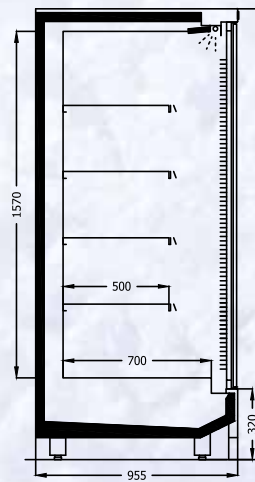

Melbourne
83.A1.DGD

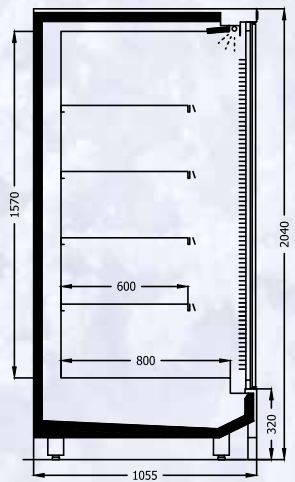

MELBOURNE D-SGD

DIŐTAN MOTORLU | REMOTE

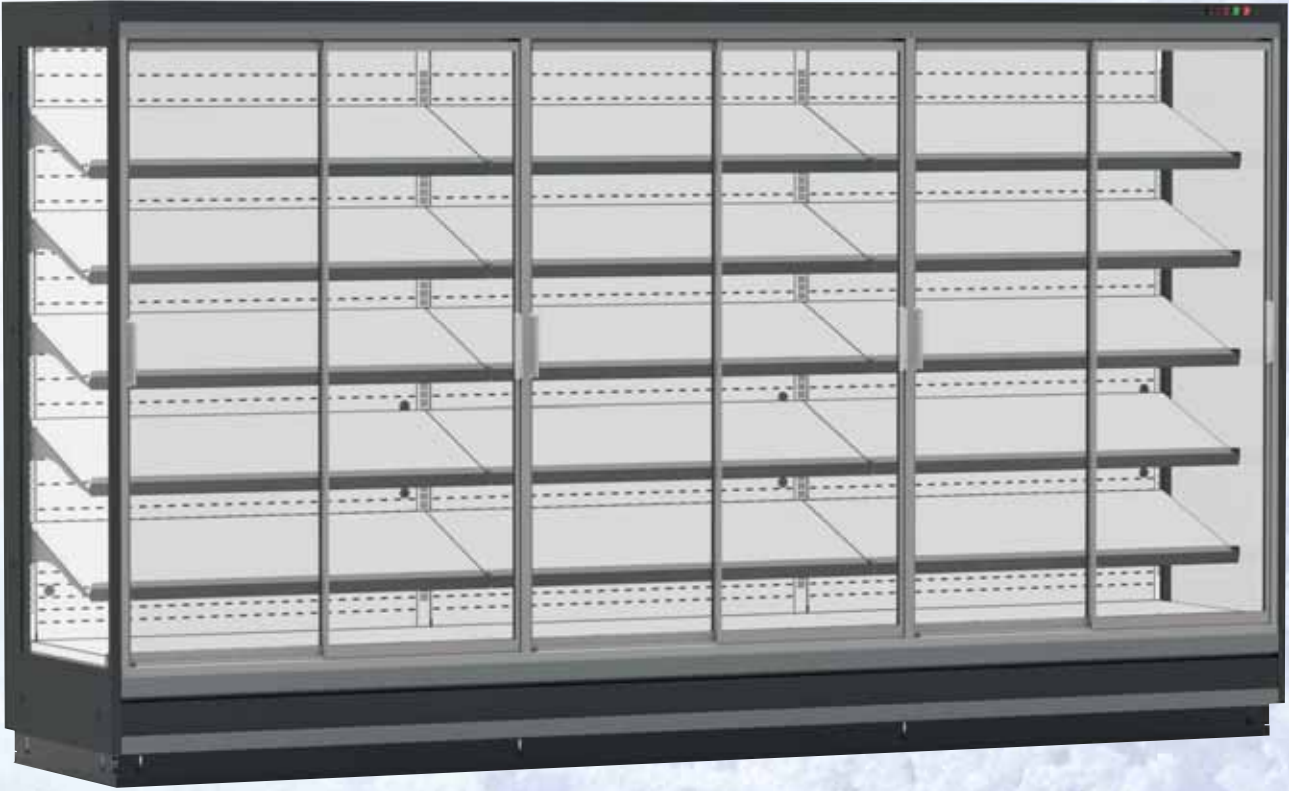

modules 0.938 1.25 1.875 2.500 2.812 3.124 3.750

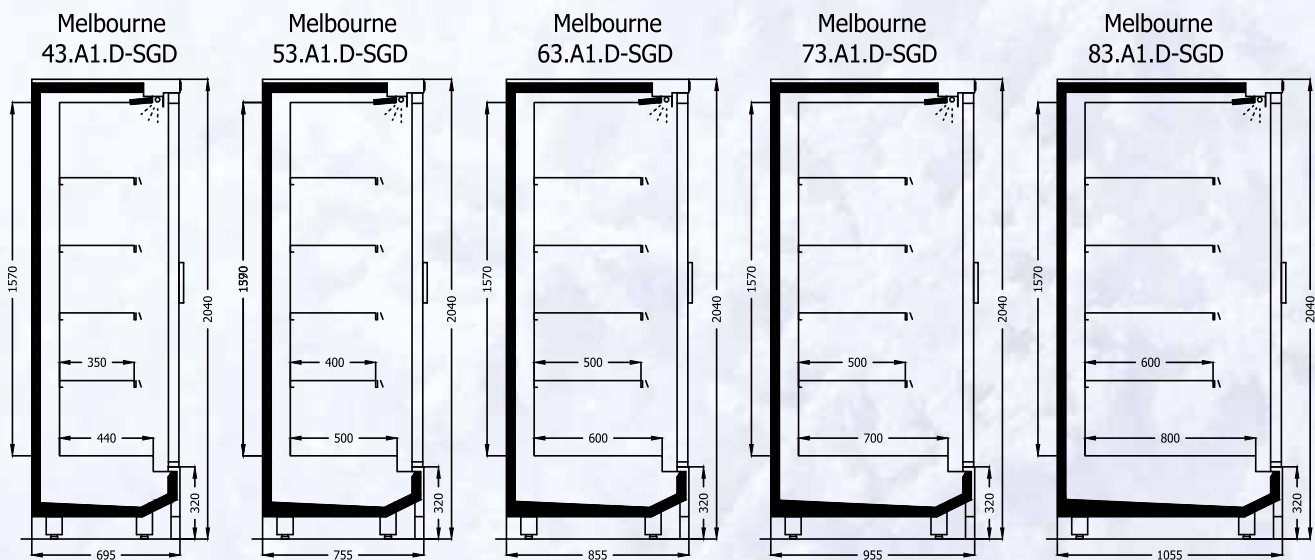
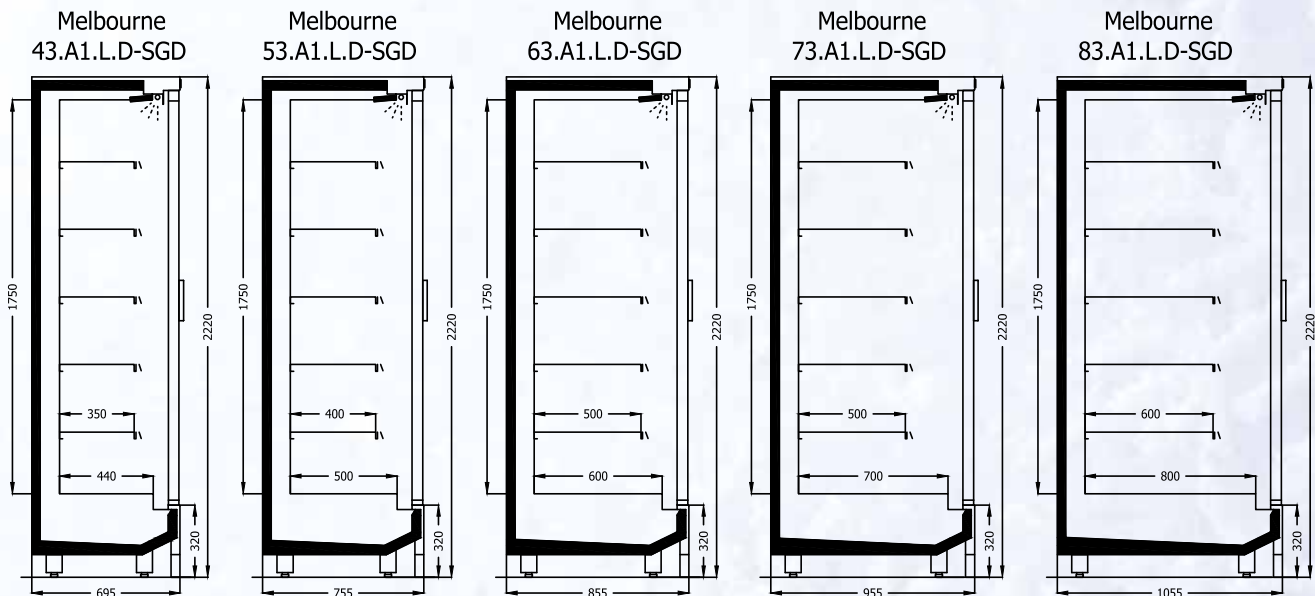

MELBOURNE OGD

DIŐTAN MOTORLU | REMOTE



modules 0.938 1.25 1.875 2.500 2.812 3.124 3.750

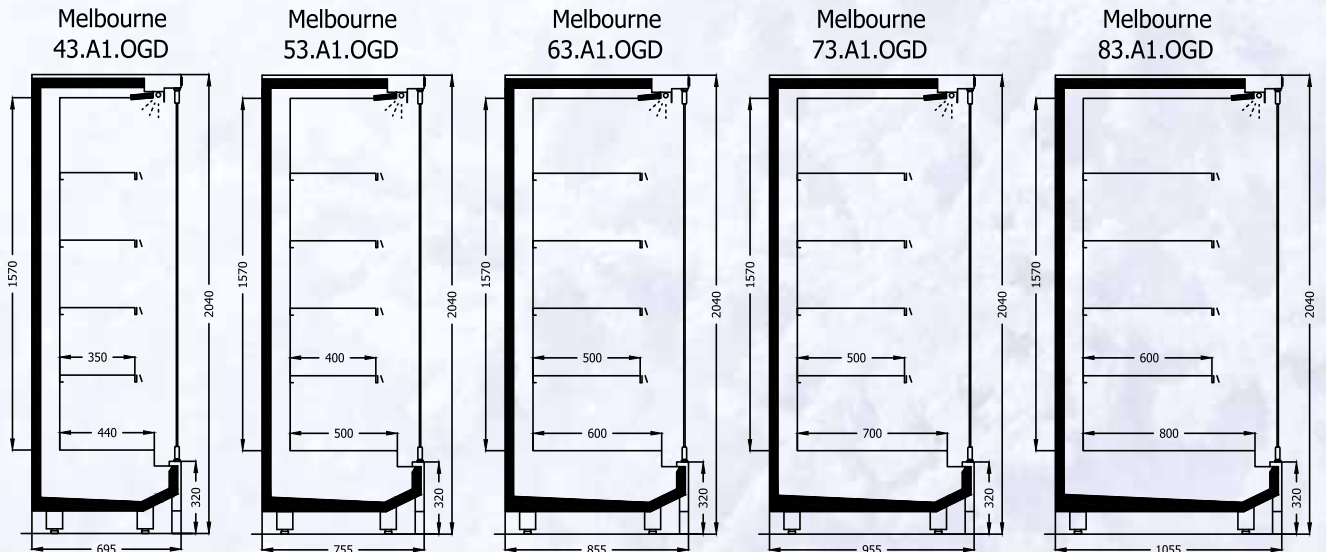
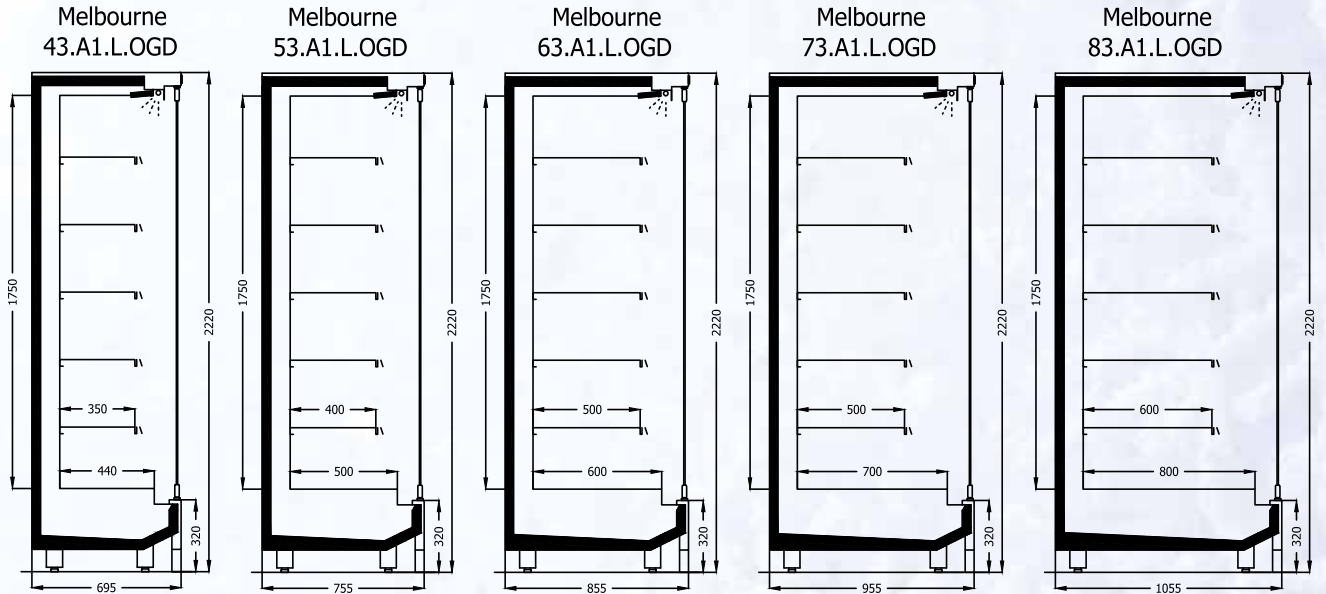

MELBOURNE HB

DIŐTAN MOTORLU | REMOTE

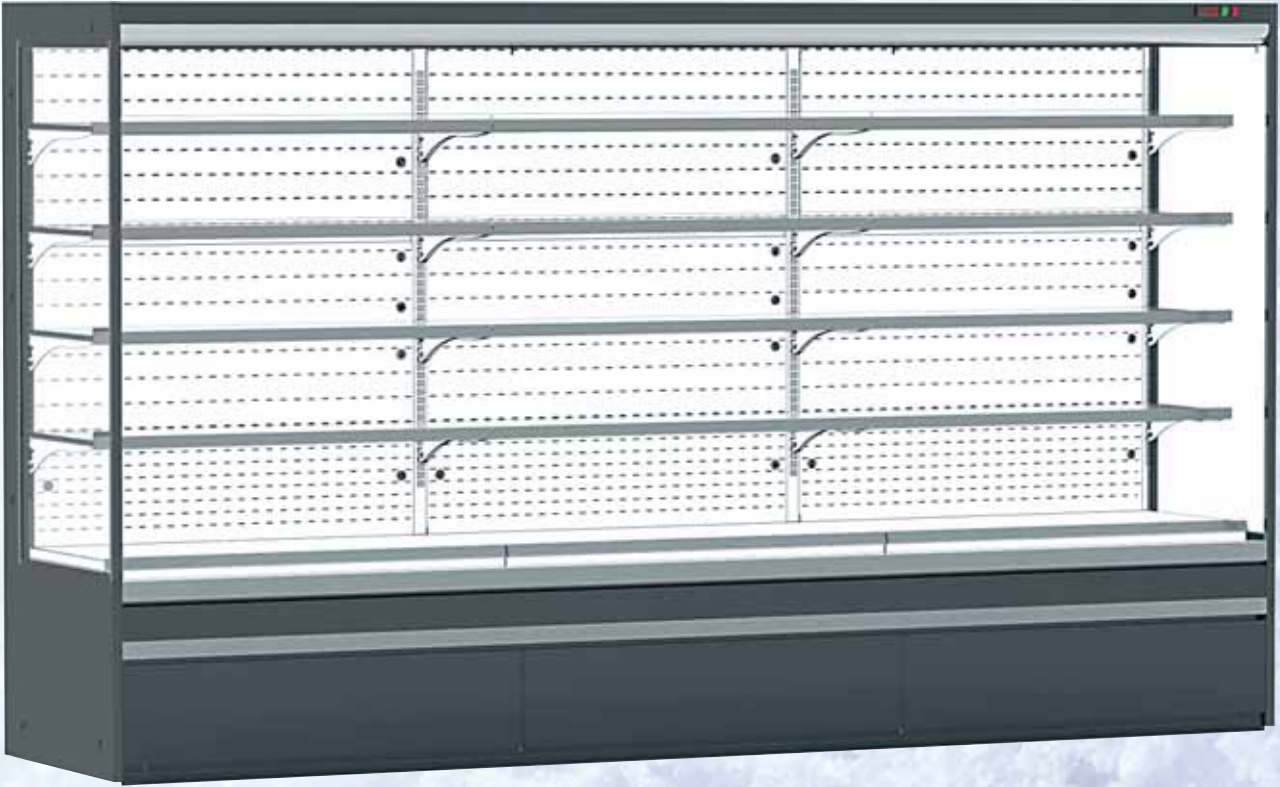

modules 0.938 1.25 1.875 2.500 2.812 3.124 3.750

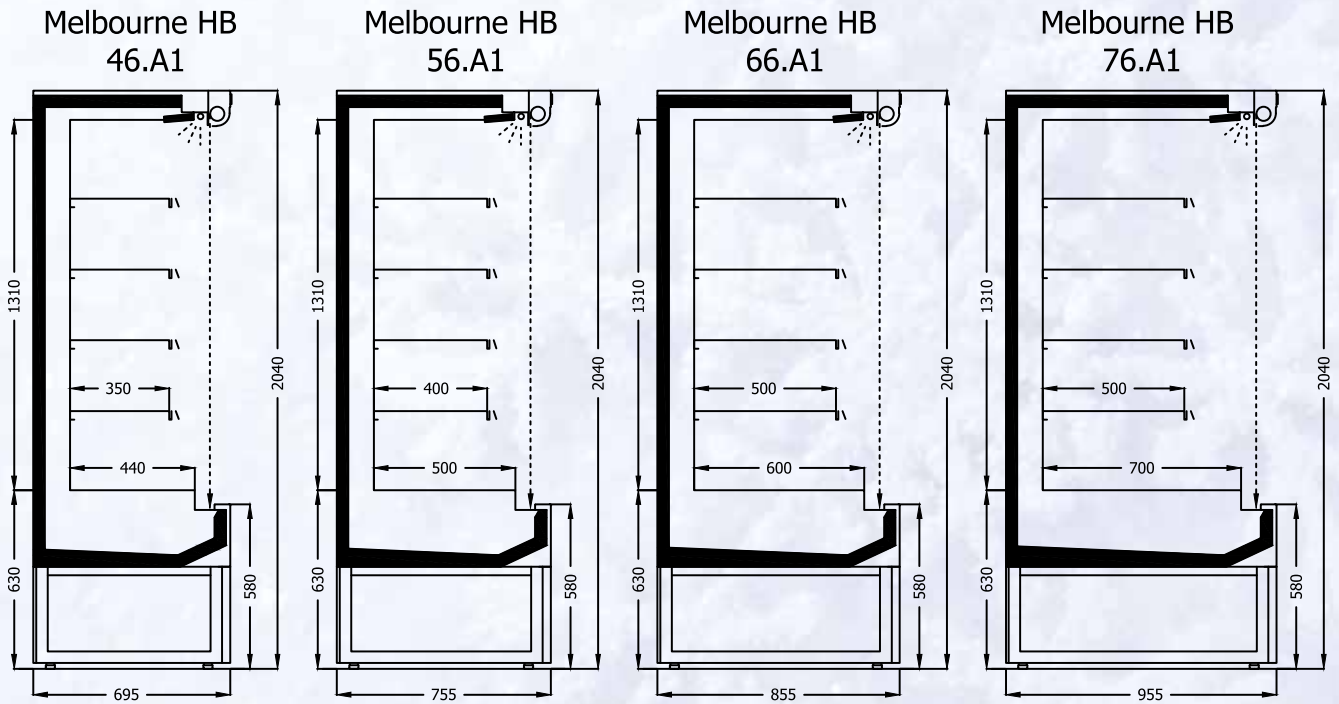
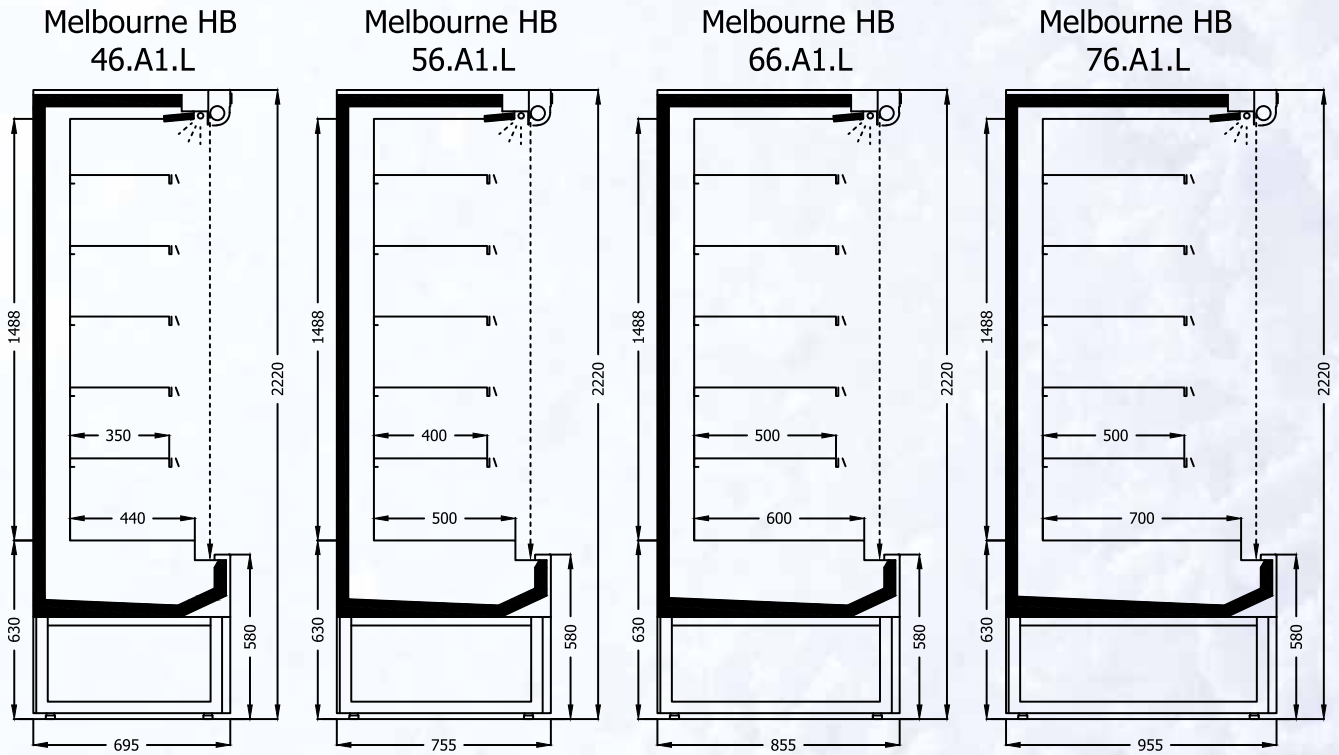

MELBOURNE HB DGD

DIŐTAN MOTORLU | REMOTE

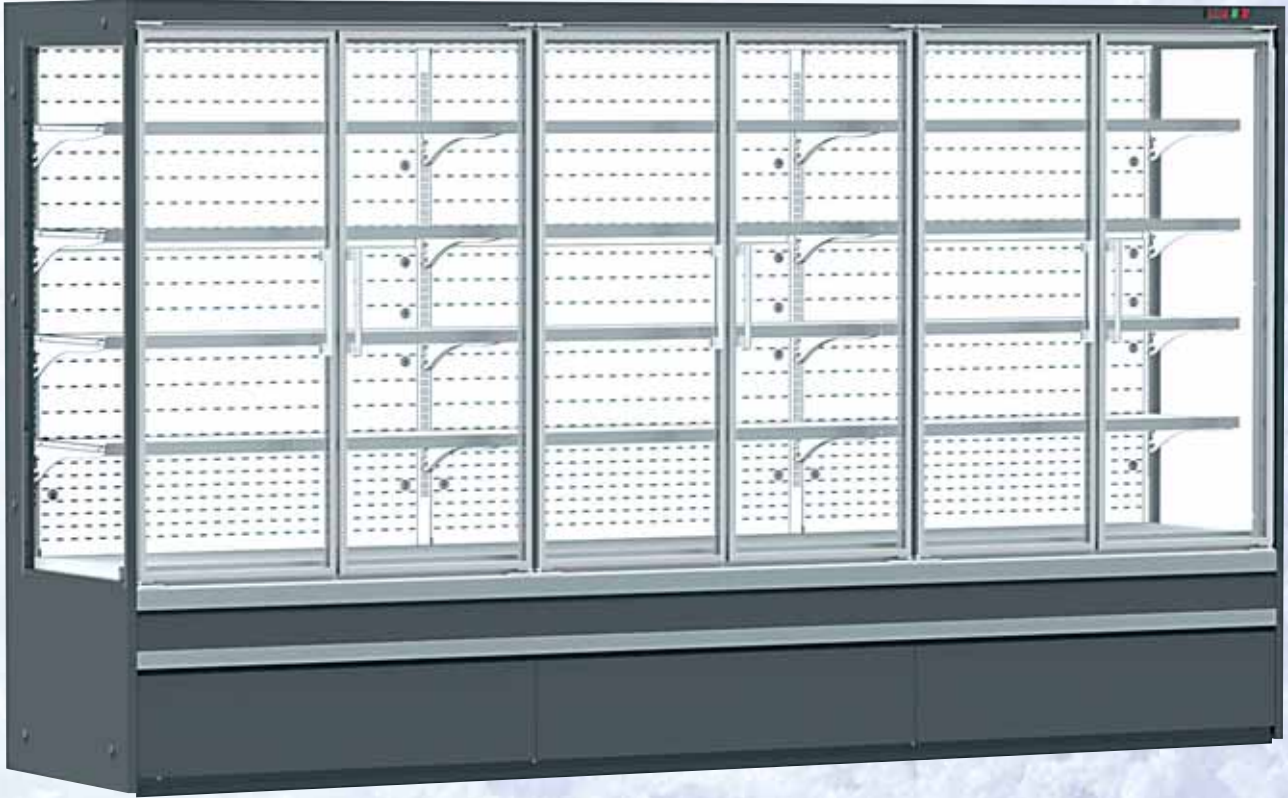

modules 0.938 1.25 1.875 2.500 2.812 3.124 3.750

Melbourne HB
46.A1.L.DGD

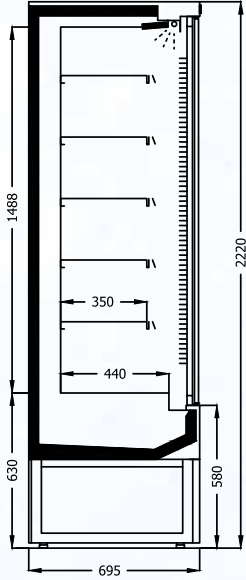

Melbourne HB
56.A1.L.DGD

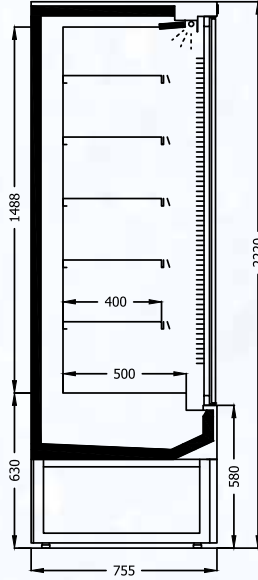

Melbourne HB
66.A1.L.DGD

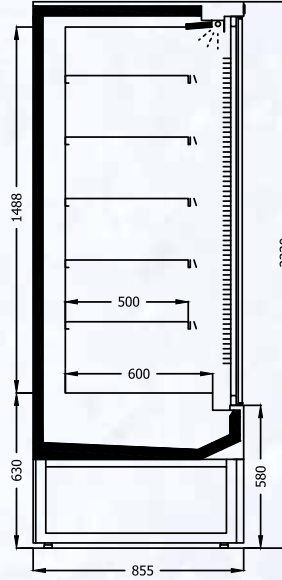

Melbourne HB
76.A1.L.DGD

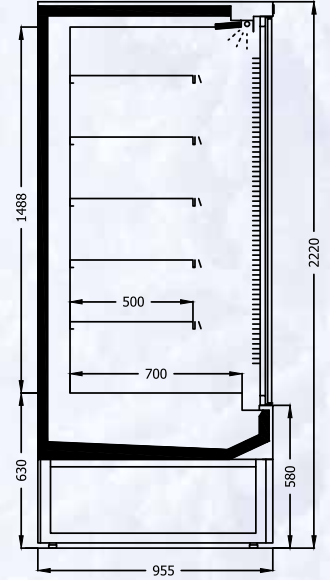

Melbourne HB
46.A1.DGD

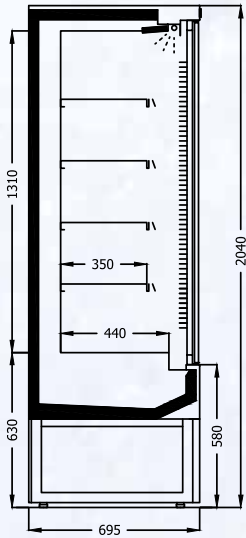

Melbourne HB
56.A1.DGD

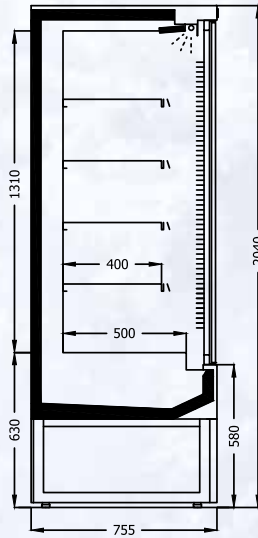

Melbourne HB
66.A1.DGD

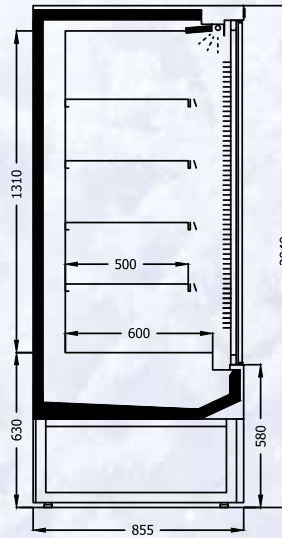

Melbourne HB
76.A1.DGD

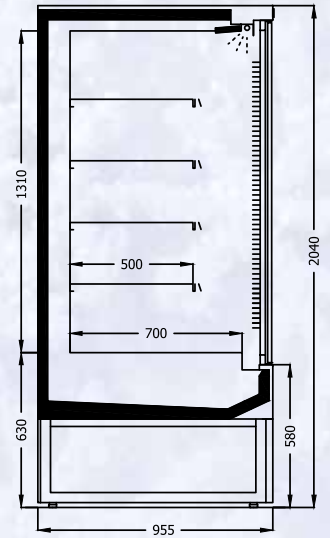

MELBOURNE HB D-SGD

DIŐTAN MOTORLU | REMOTE

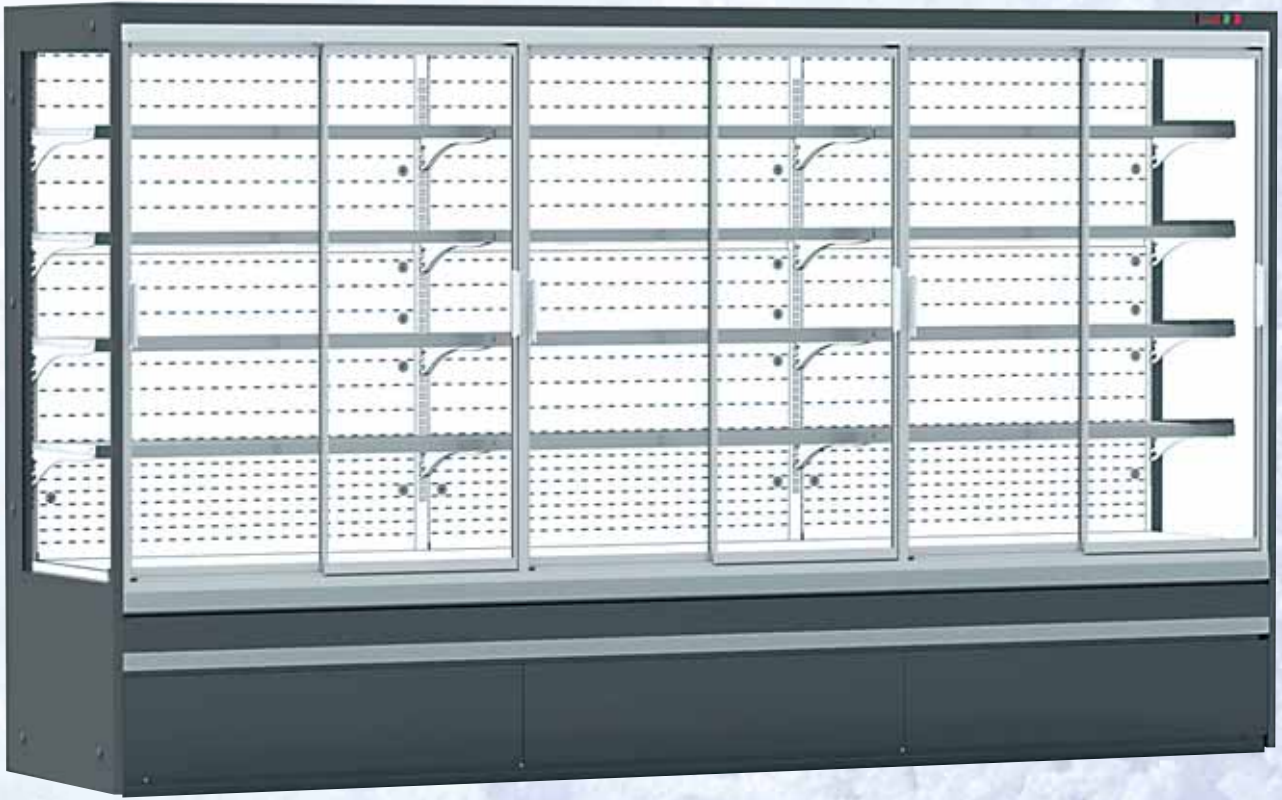

modules 0.938 1.25 1.875 2.500 2.812 3.124 3.750

Melbourne HB
46.A1.L.D-SGD

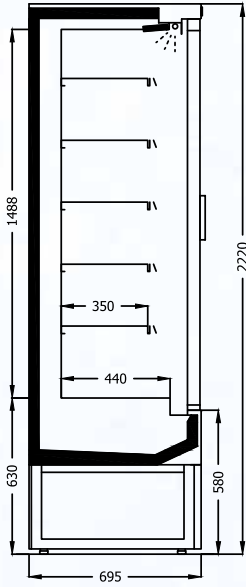

Melbourne HB
56.A1.L.D-SGD

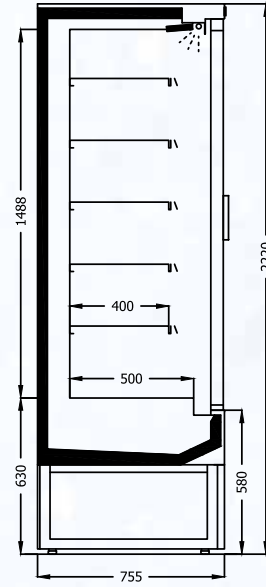

Melbourne HB
66.A1.L.D-SGD

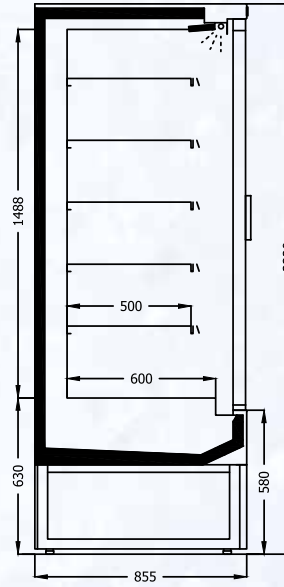

Melbourne HB
76.A1.L.D-SGD

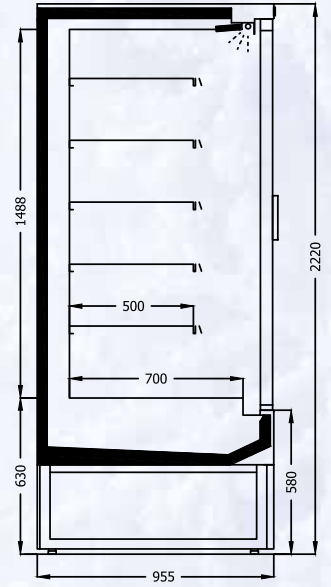

Melbourne HB
46.A1.D-SGD

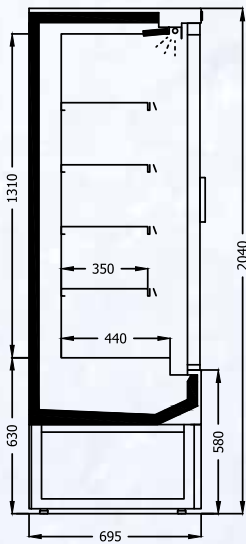

Melbourne HB
56.A1.D-SGD

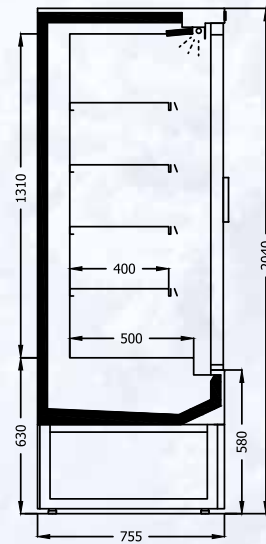

Melbourne HB
66.A1.D-SGD

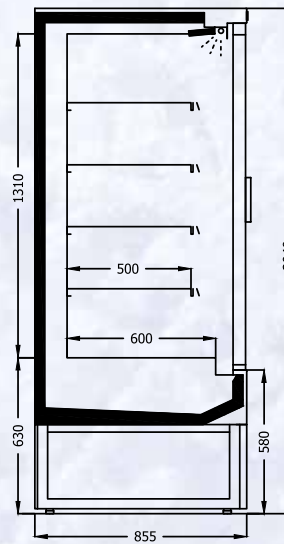

Melbourne HB
76.A1.D-SGD

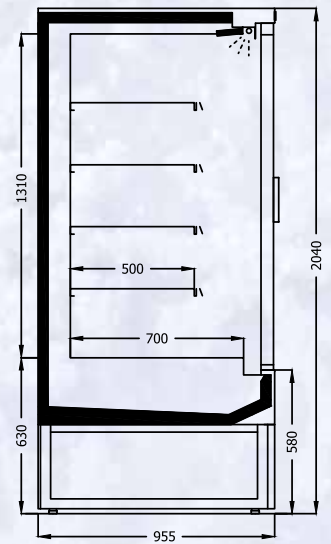

MELBOURNE HB D-OGD

DIŐTAN MOTORLU | REMOTE

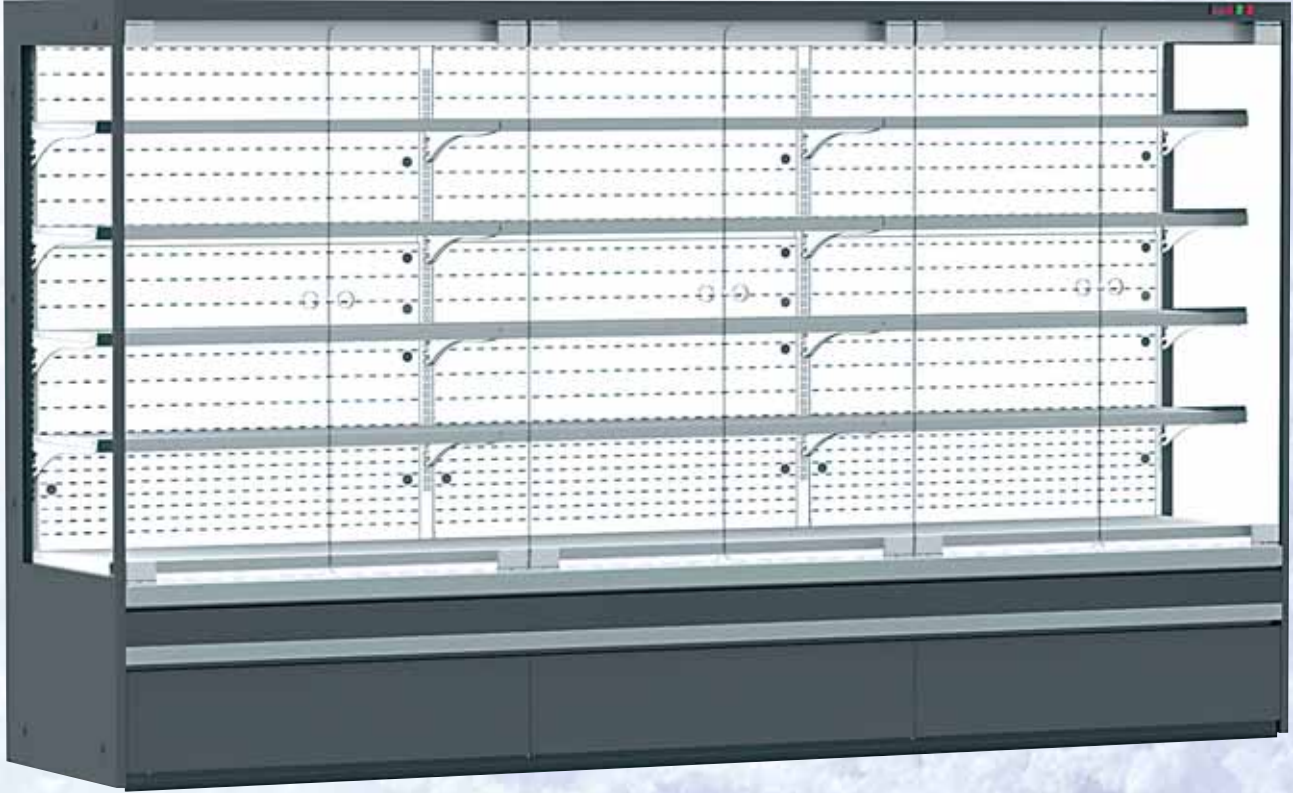

modules 0.938 1.25 1.875 2.500 2.812 3.124 3.750

Melbourne HB
46.A1.L.OGD

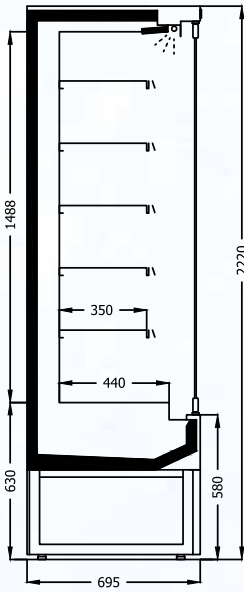

Melbourne HB
56.A1.L.OGD

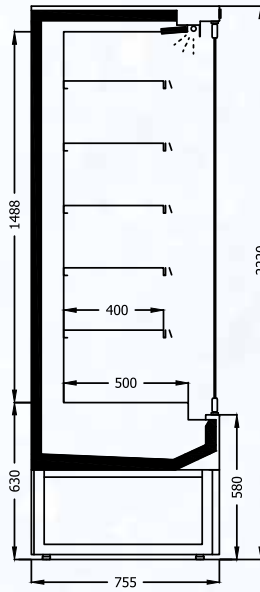

Melbourne HB
66.A1.L.OGD

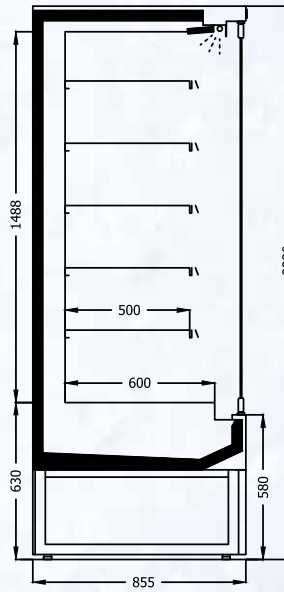

Melbourne HB
76.A1.L.OGD

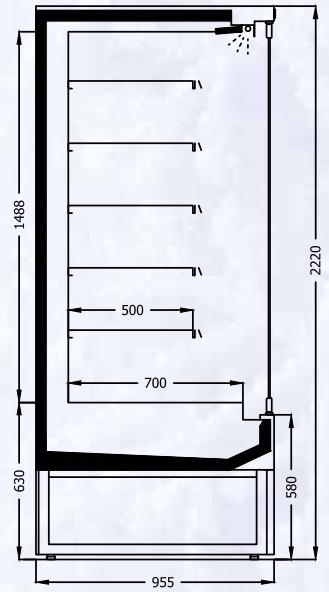

Melbourne HB
46.A1.OGD

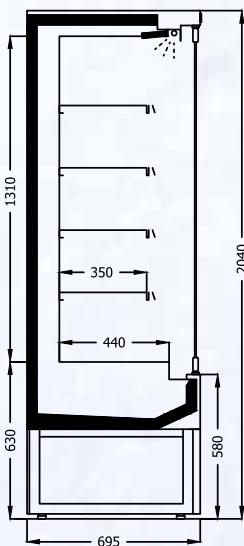

Melbourne HB
56.A1.OGD

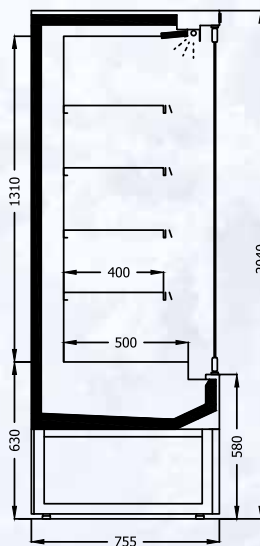

Melbourne HB
66.A1.OGD

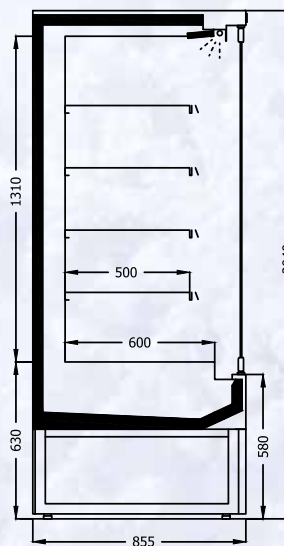

Melbourne HB
76.A1.OGD

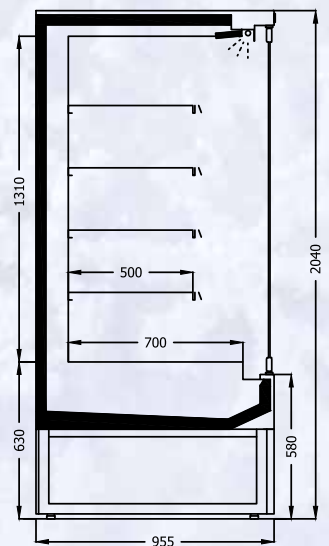

MELBOURNE WB

DIŐTAN MOTORLU | REMOTE

MELBOURNE WB



MELBOURNE WB O-SGD



modules 1.25 1.875 2.500 3.750

Melbourne WB
58.A1.L

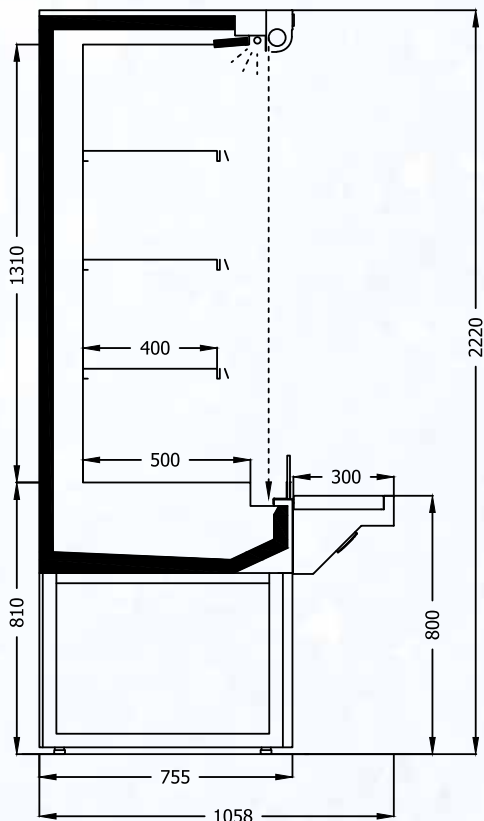

Melbourne WB
68.A1.L

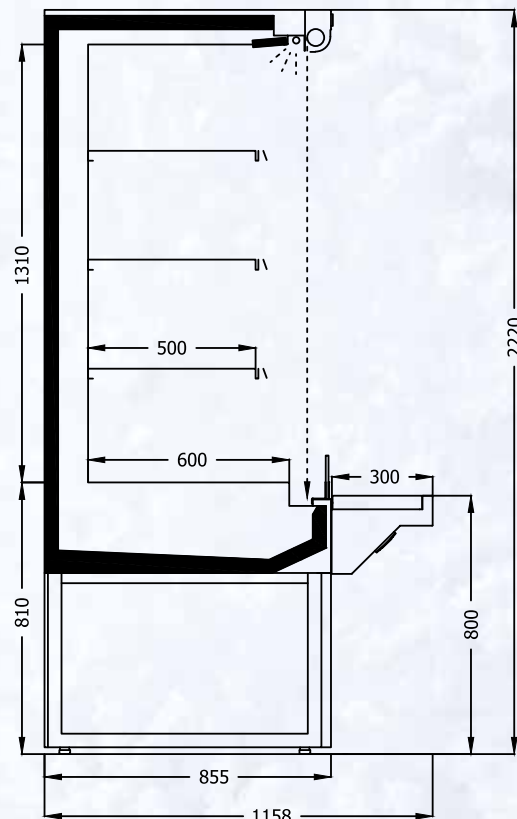

Melbourne WB
58.A1.L.O-SGD

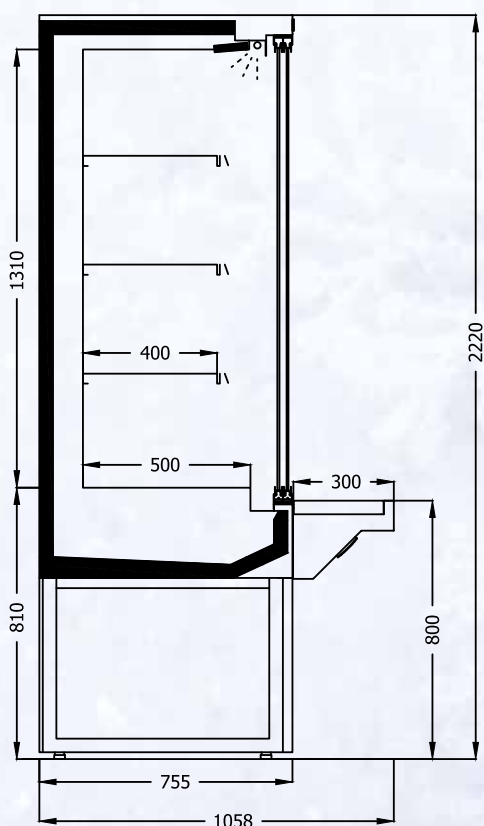

Melbourne WB
68.A1.L.O-SGD

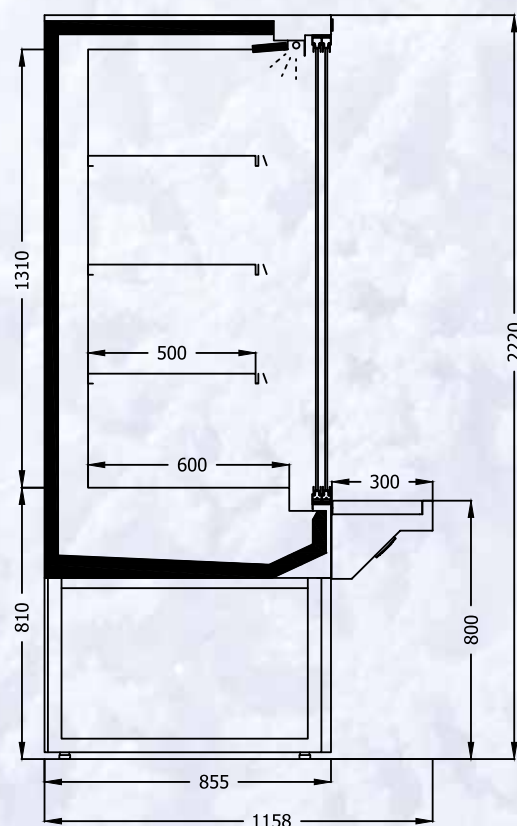

MELBOURNE RB

DIŐTAN MOTORLU | REMOTE

MELBOURNE RB

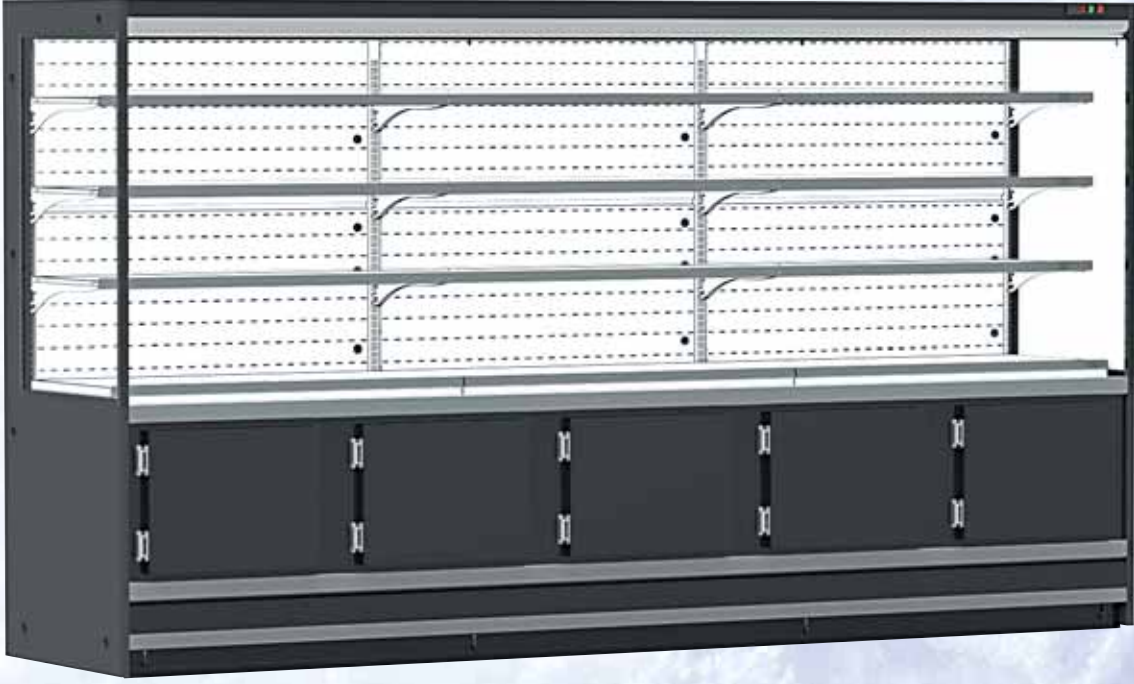

MELBOURNE RB DGD

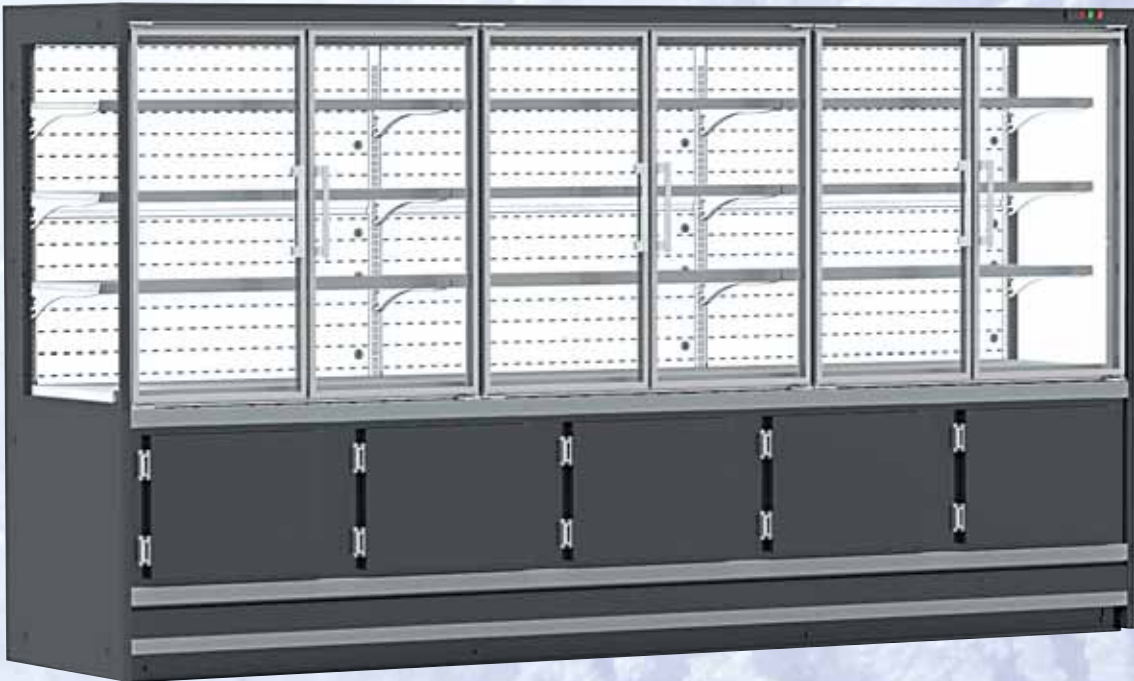

modules 1.25 1.875 2.500 3.750

Melbourne RB
58.A1.L

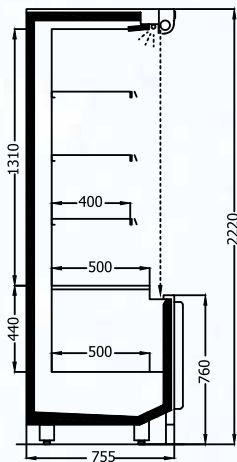

Melbourne RB
68.A1.L

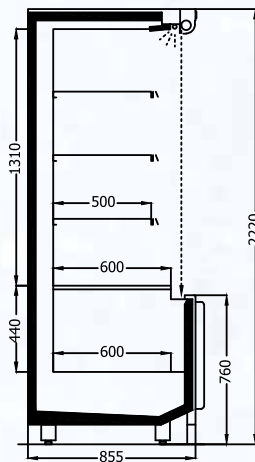

Melbourne RB
78.A1.L

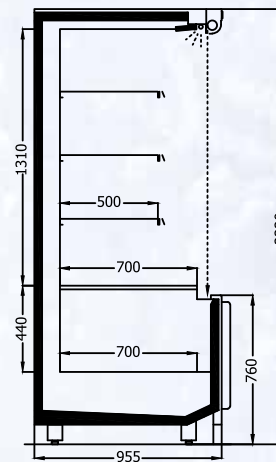

Melbourne RB
58.A1.L.DGD

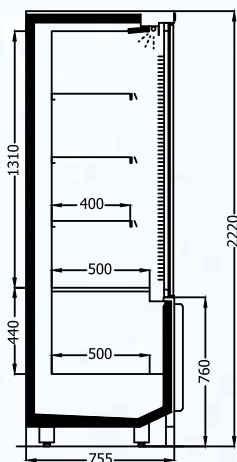

Melbourne RB
68.A1.L.DGD

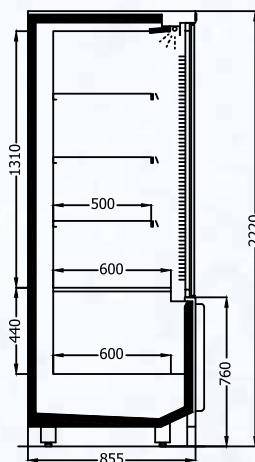

Melbourne RB
78.A1.L.DGD

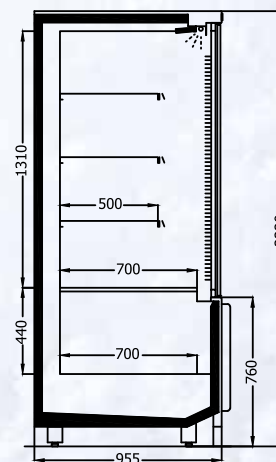

Melbourne RB
58.A1

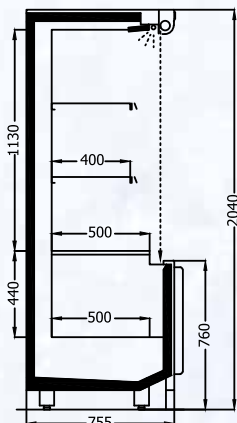

Melbourne RB
68.A1

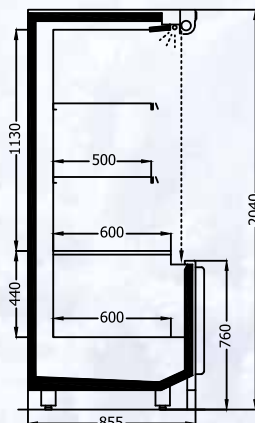

Melbourne RB
78.A1

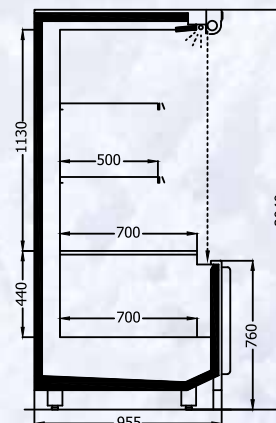

Melbourne RB
58.A1.DGD

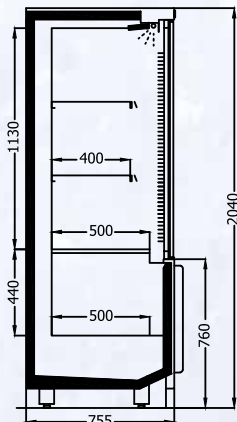

Melbourne RB
68.A1.DGD

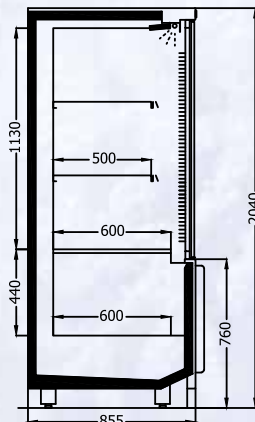

Melbourne RB
78.A1.DGD

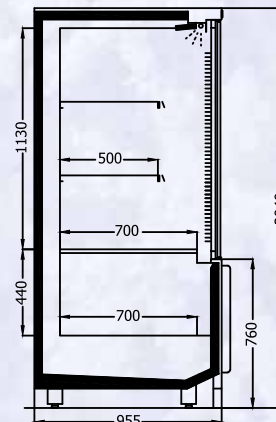

MELBOURNE FV

DIŞTAN MOTORLU | REMOTE



modules 1.25 1.875 2.500 2.812 3.124 3.750

Melbourne FV
43.A1.L

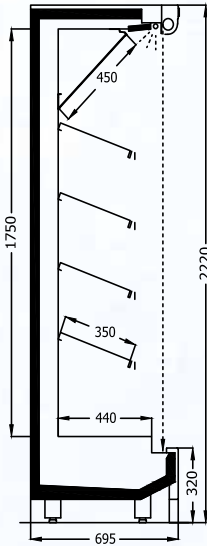

Melbourne FV
53.A1.L

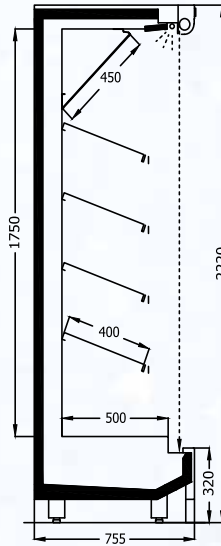

Melbourne FV
63.A1.L

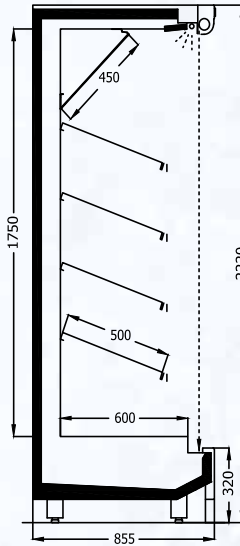

Melbourne FV
73.A1.L

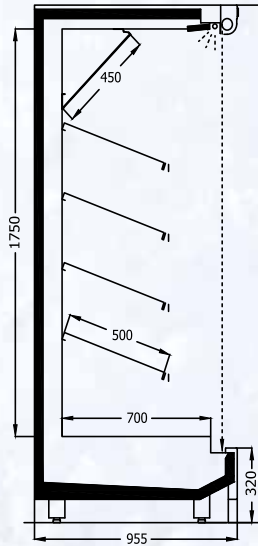

Melbourne FV
83.A1.L

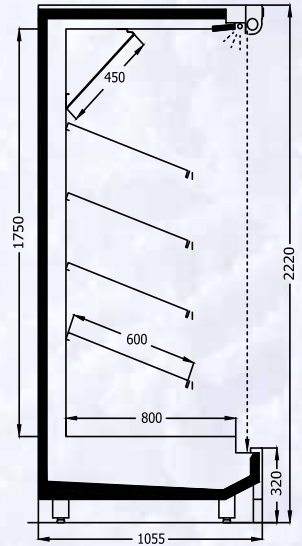

Melbourne FV
43.A1

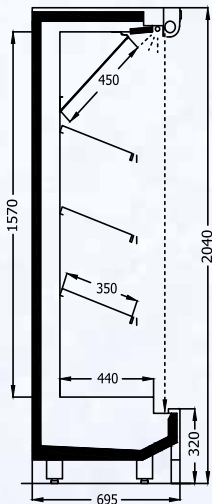

Melbourne FV
53.A1

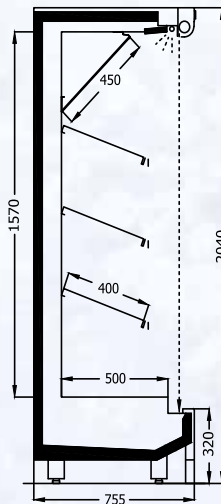

Melbourne FV
63.A1

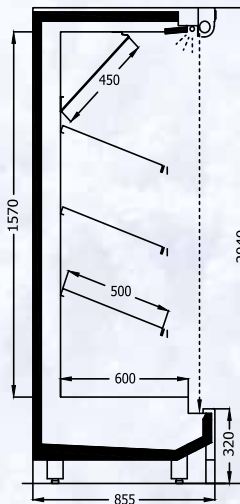

Melbourne FV
73.A1

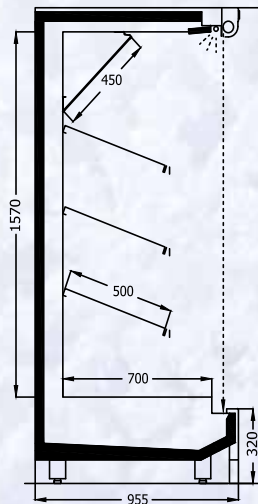

Melbourne FV
83.A1

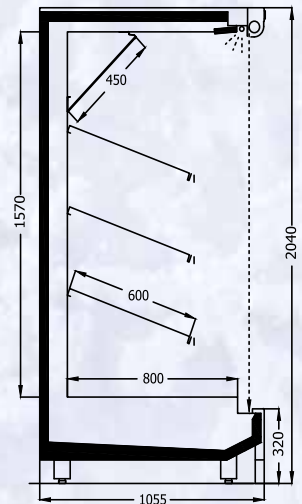

DARWIN

DIŐTAN MOTORLU | REMOTE



modules 1.25 1.875 2.500

Darwin
76.A1.L.DGD

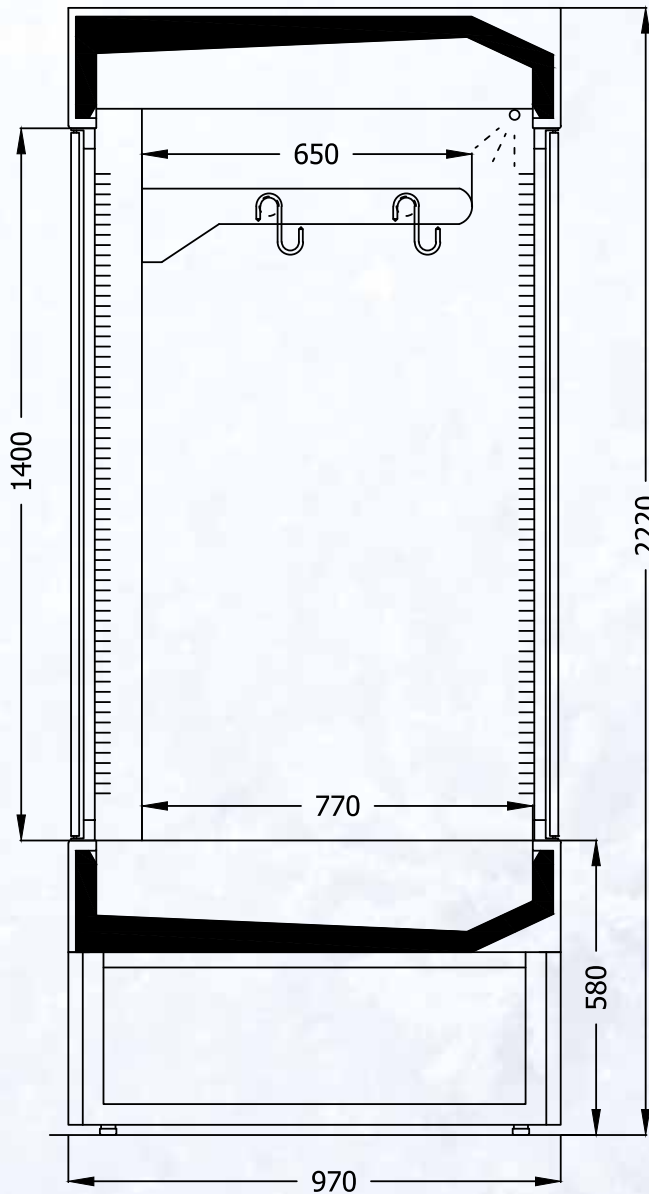

Darwin
76.A1.L.DGD

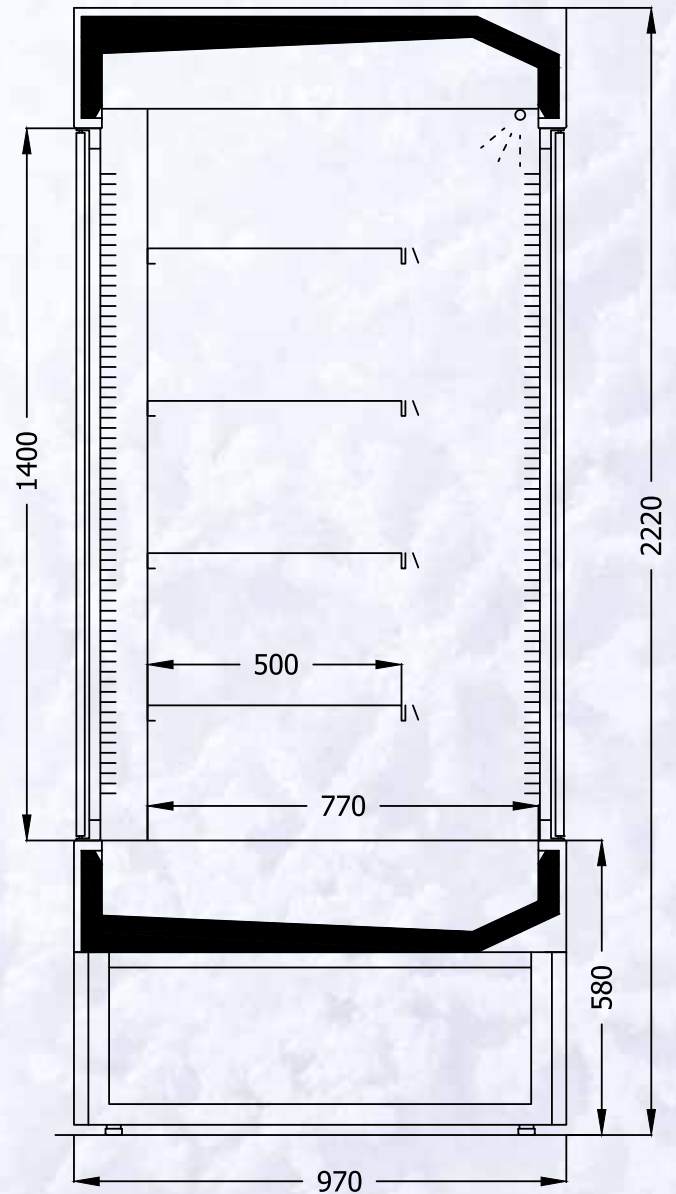

MARLO

DIŐTAN MOTORLU | REMOTE

MARLO



MARLO ECO



modules 1.562 2.343 3.124 3.905

Marlo
53.A1.L

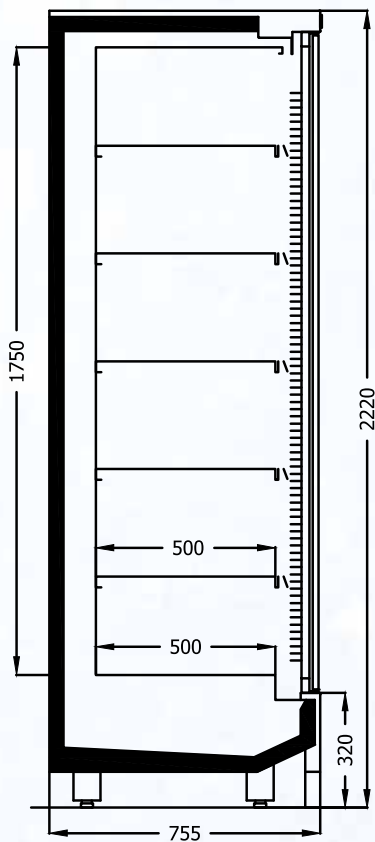

Marlo
63.A1.L

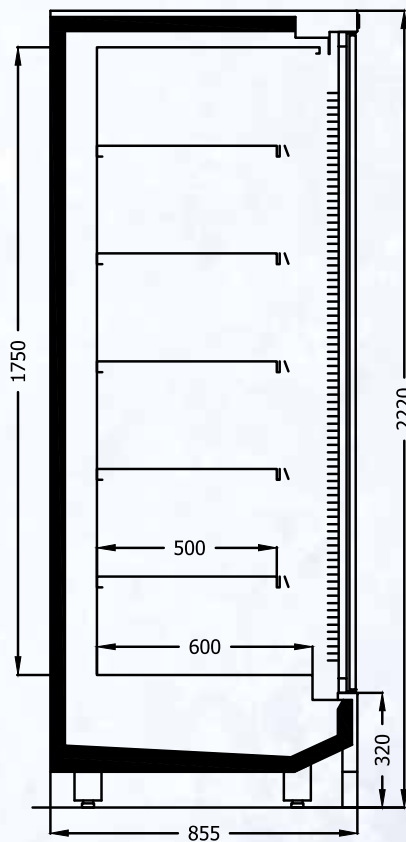

Marlo Eco
53.A1.L

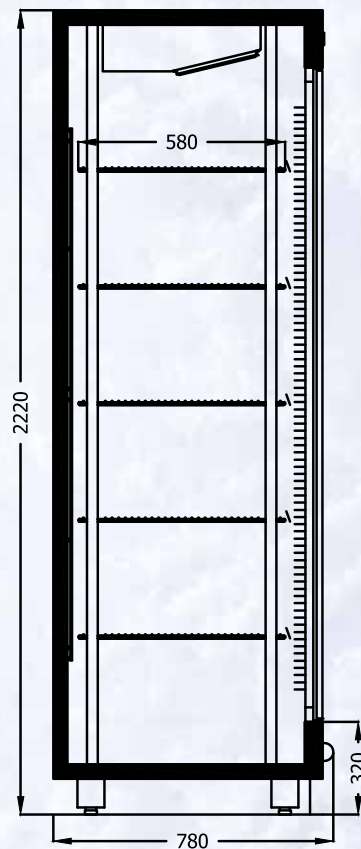

Marlo
53.A1

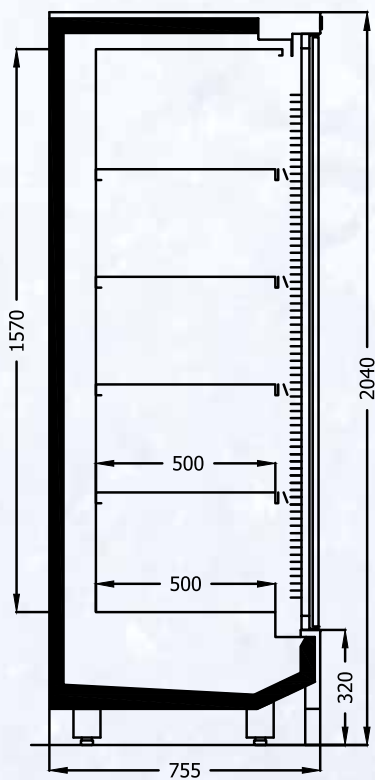

Marlo
63.A1

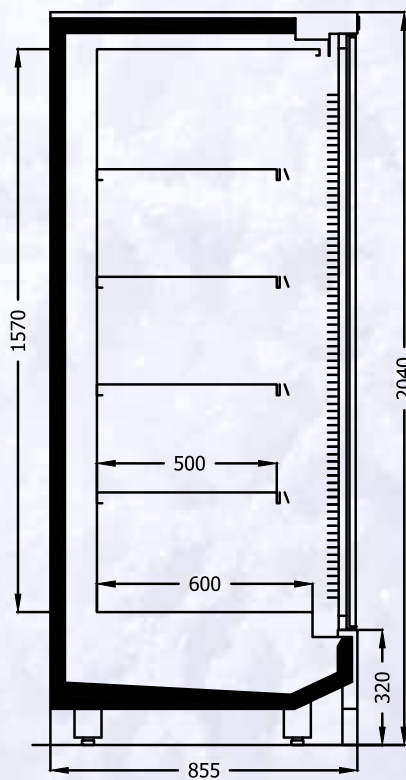

Marlo Eco
53.A1

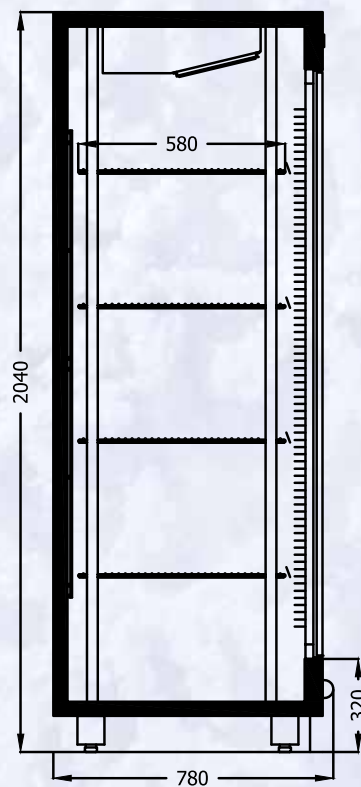

SÜTLÜK | MULTIDECKS

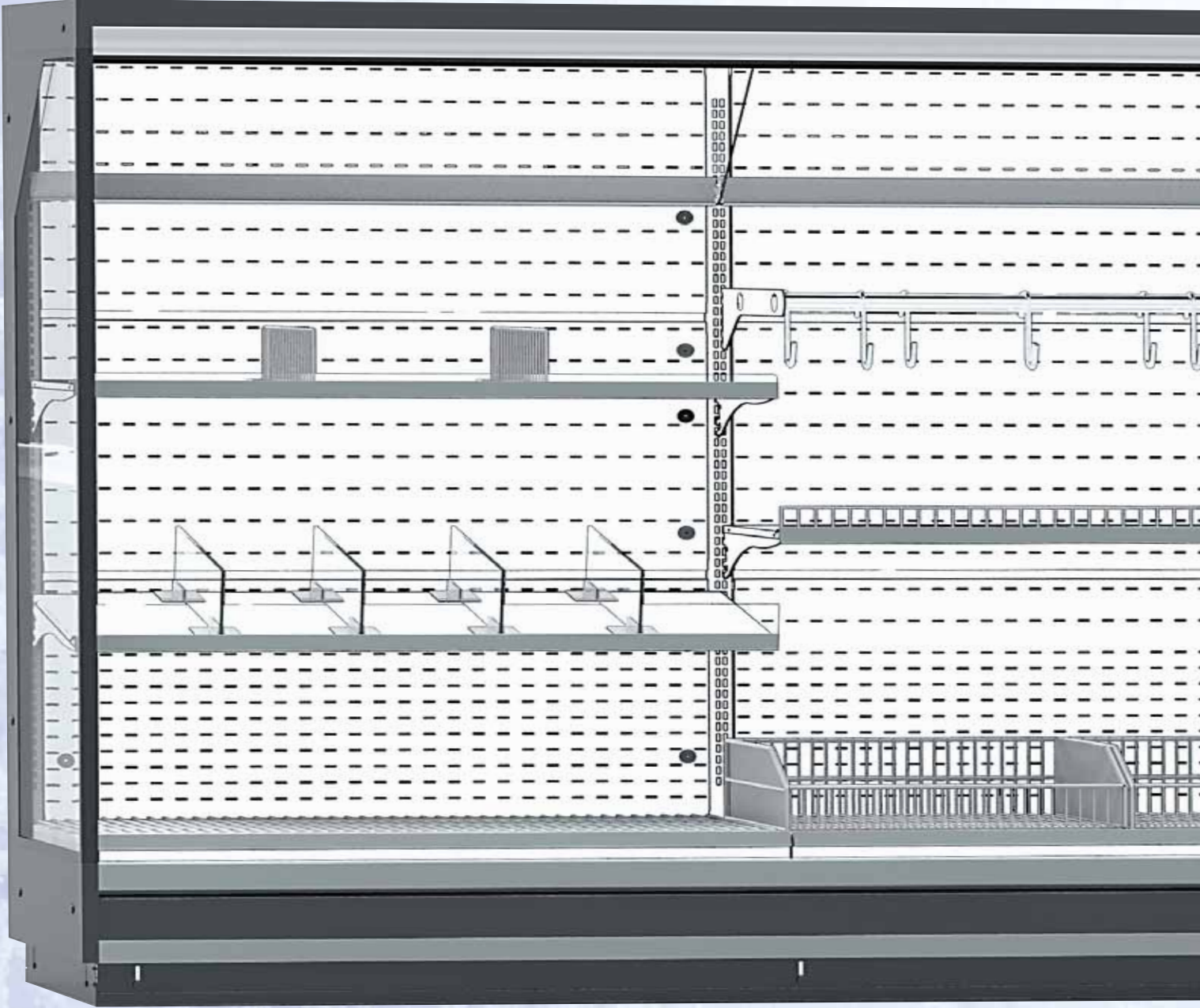

DIŐTAN MOTORLU | REMOTE

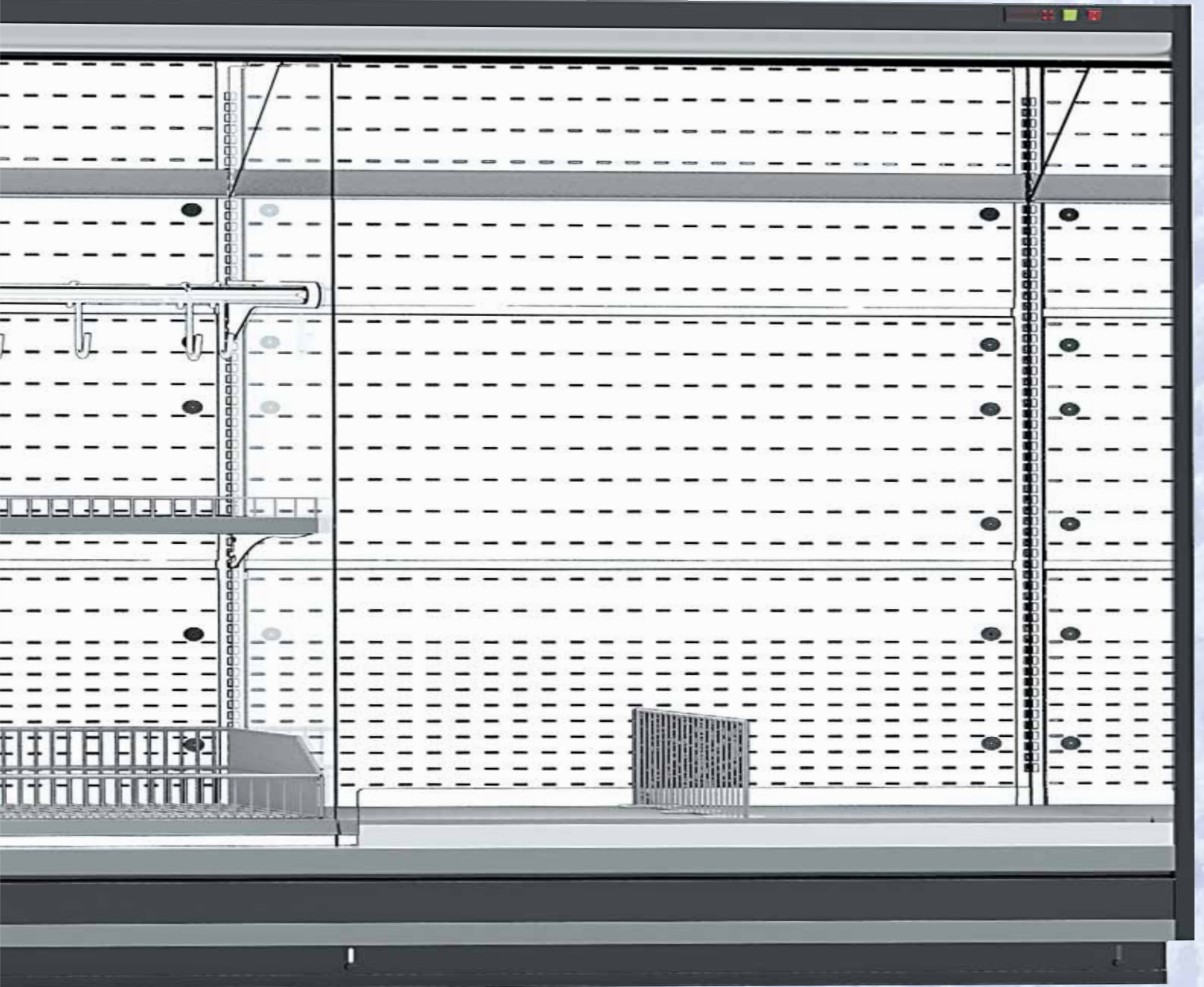

MARBELLA

DIŐTAN MOTORLU | REMOTE

MARBELLA



MARBELLA D-SGD

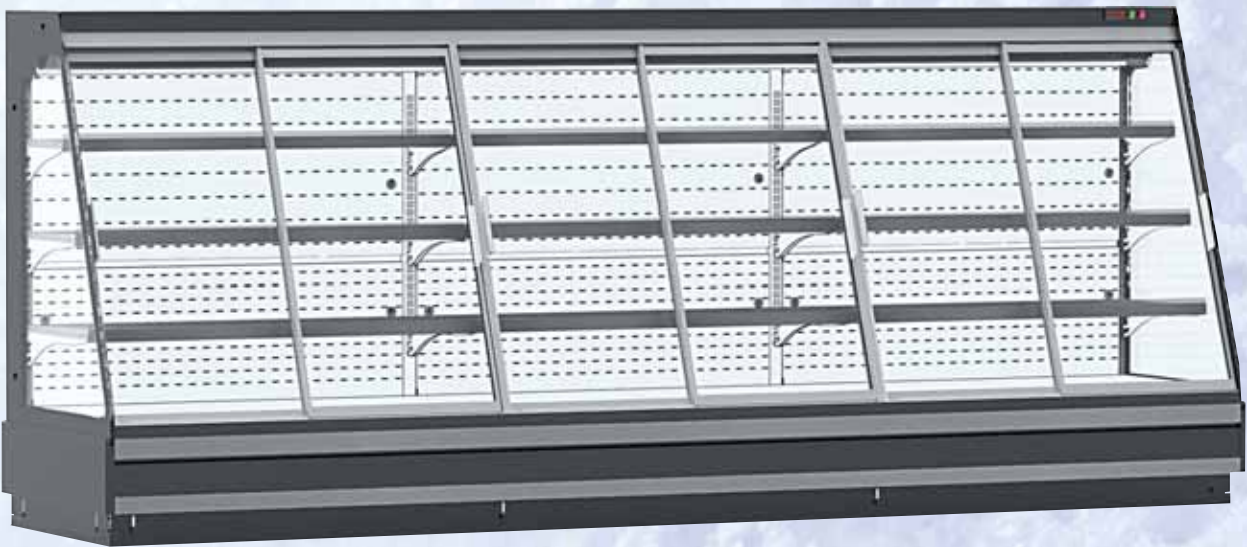

modules 1.25 1.875 2.500 3.124 3.750

Marbella
53.A1 H:1550

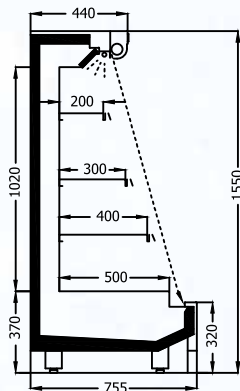

Marbella
63.A1 H:1550

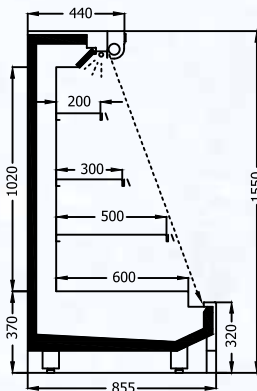

Marbella
73.A1 H:1550

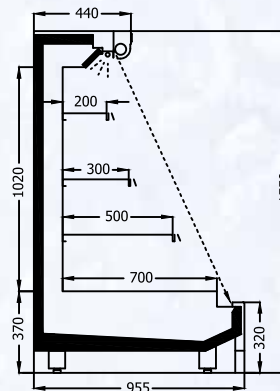

Marbella
53.A1.SGD H:1550

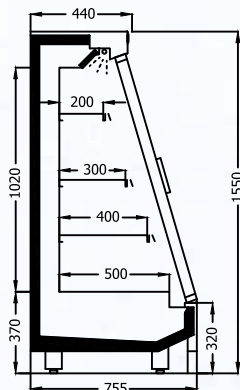

Marbella
63.A1.SGD H:1550

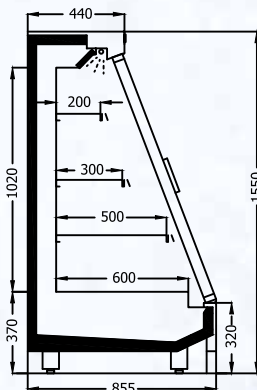

Marbella
73.A1.SGD H:1550

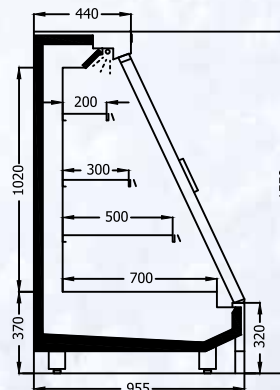

Marbella
56.A1 H:1550

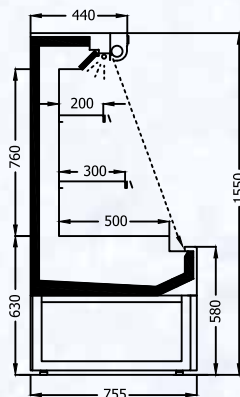

Marbella
66.A1 H:1550

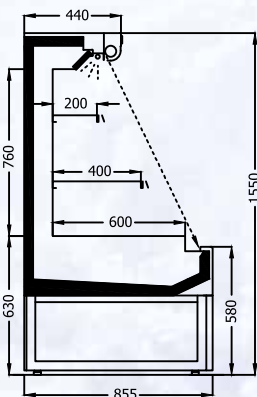

Marbella
76.A1 H:1550

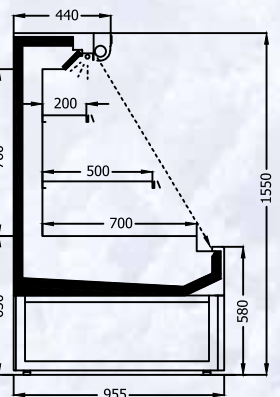

Marbella
56.A1.SGD H:1550

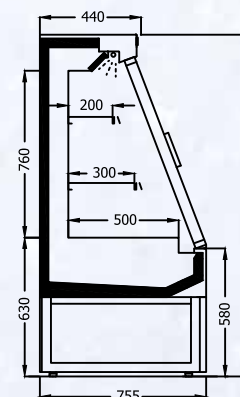

Marbella
66.A1.SGD H:1550

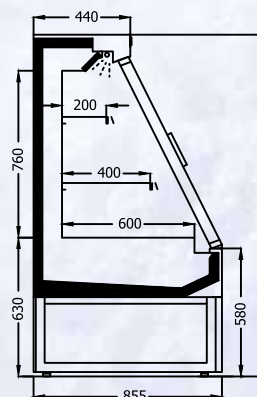

Marbella
76.A1.SGD H:1550

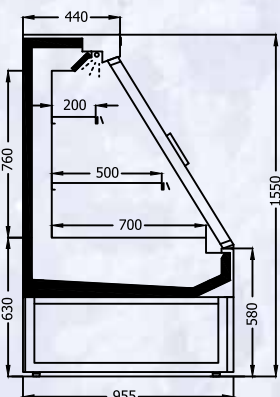

MANAMA

DIŐTAN MOTORLU | REMOTE



modules 1.562 2.340 3.124 3.905

Manama
63.A1.L

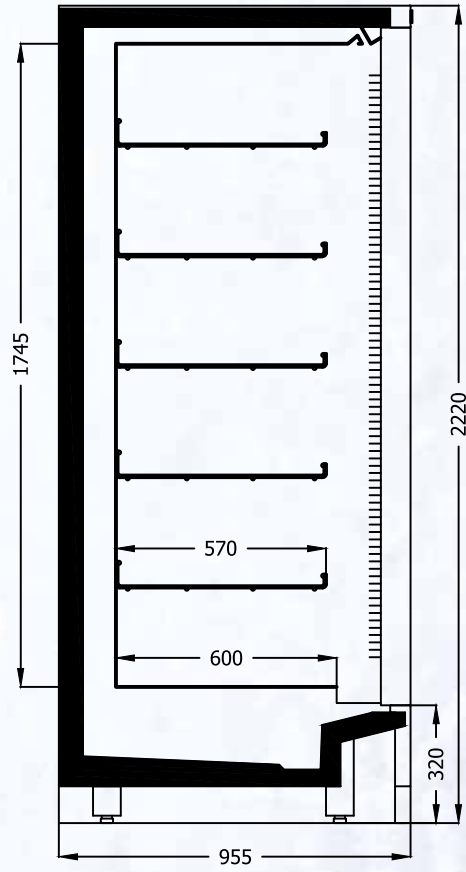

Manama
63.A1

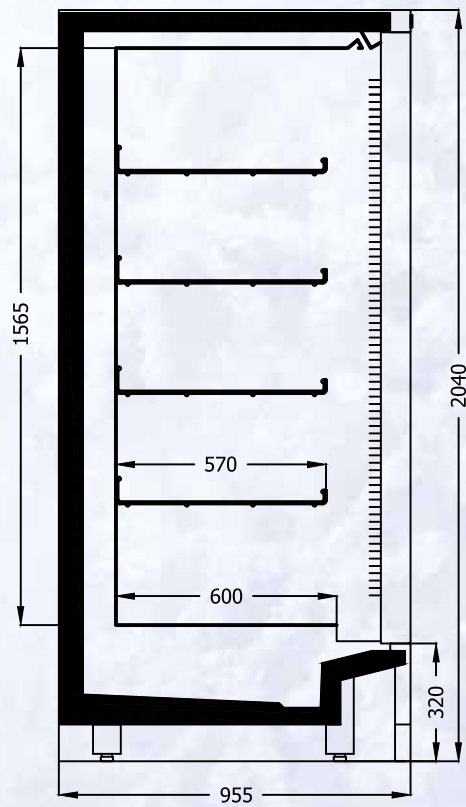

SPARTA CG-FG

İÇTEN MOTORLU | PLUG - IN

SPARTA CG



SPARTA FG



modules 0.938 1.25 1.875 2.500 2.812

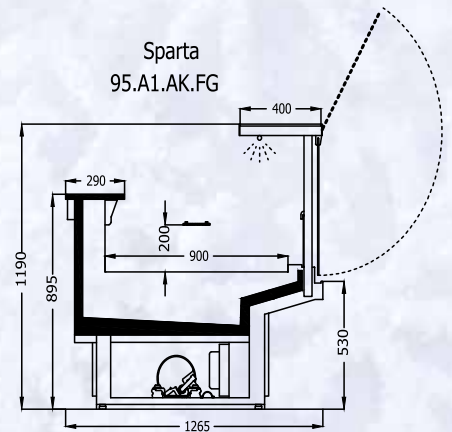
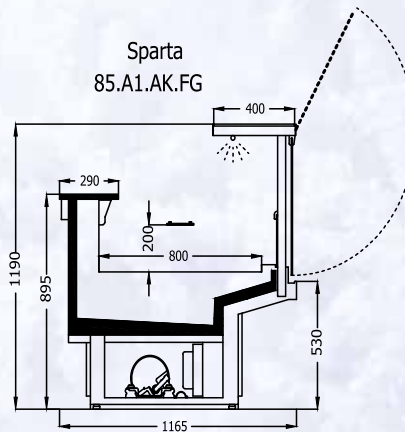
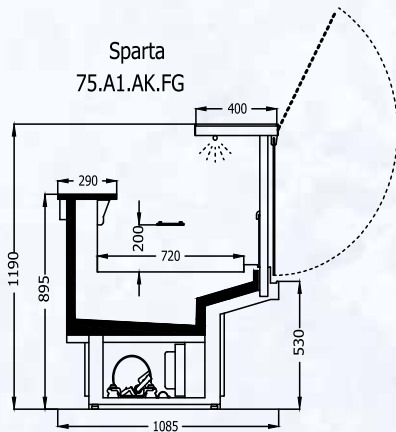
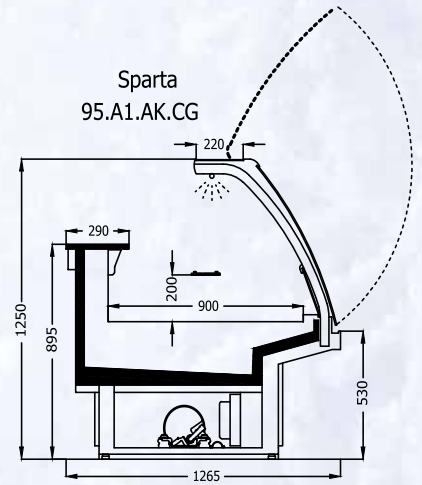
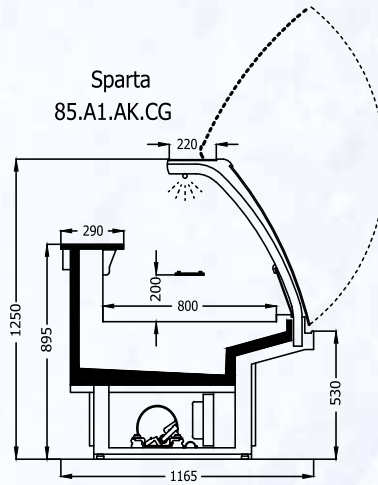
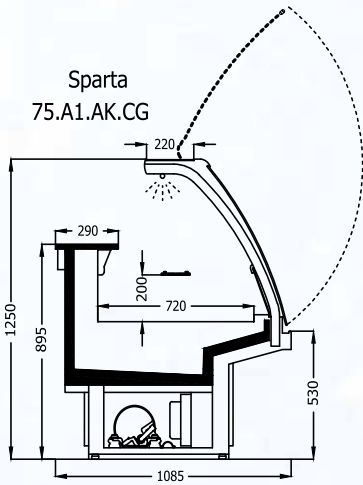

SPARTA AFG

İÇTEN MOTORLU | PLUG - IN



modules 0.938 1.25 1.875 2.500 2.812

Sparta
75.A1.AK.AFG

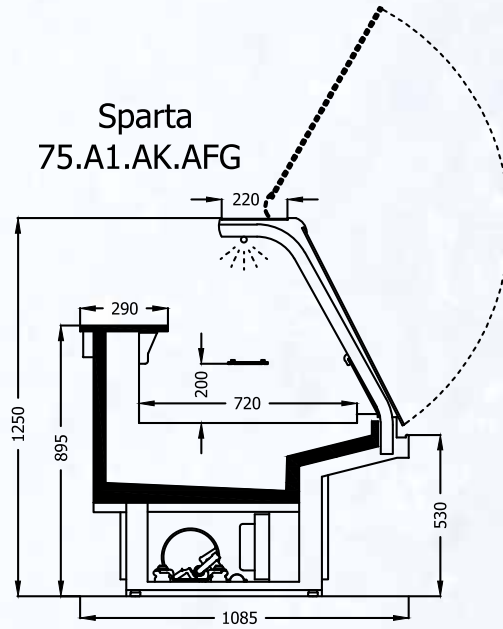

Sparta
85.A1.AK.AFG

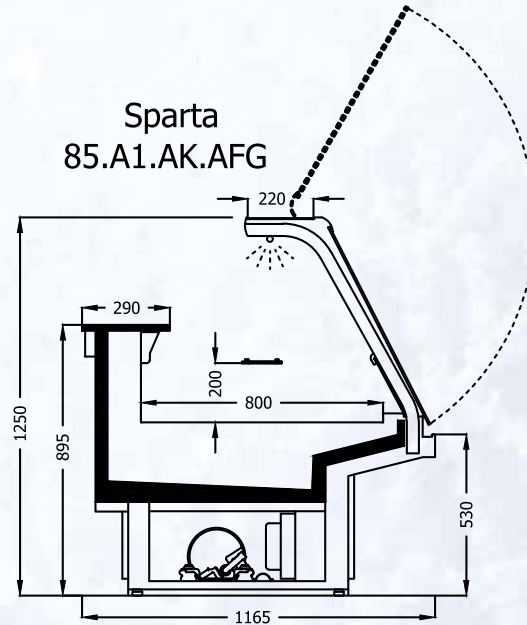

Sparta
95.A1.AK.AFG

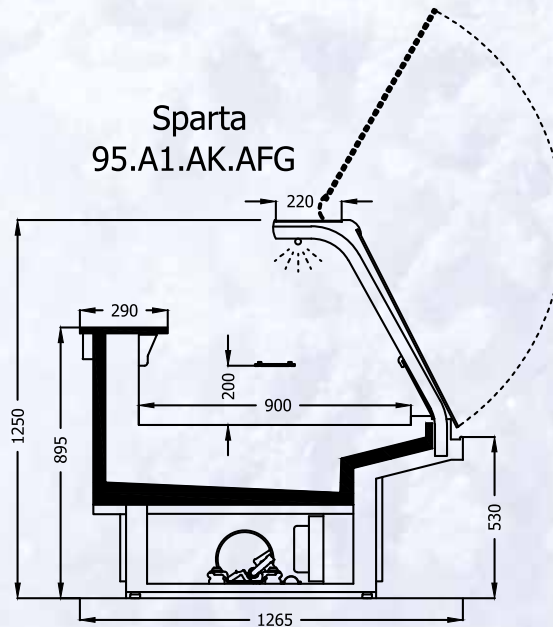

SPARTA SS.CG-FG

İÇTEN MOTORLU | PLUG - IN

SPARTA SS.CG



SPARTA SS.FG



modules 0.938 1.25 1.875 2.500 2.812

Sparta
75.A1.AK.SS.CG

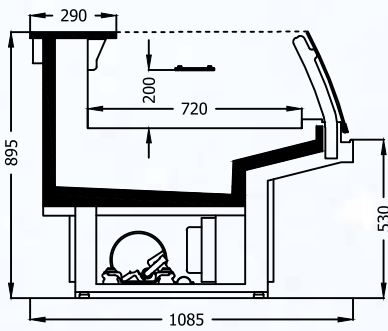

Sparta
85.A1.AK.SS.CG

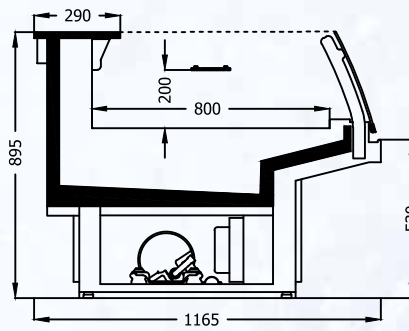

Sparta
95.A1.AK.SS.CG

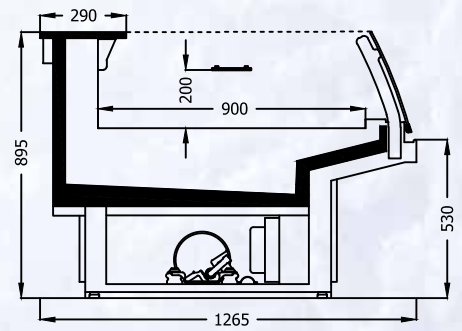

Sparta
75.A1.AK.SS.FG

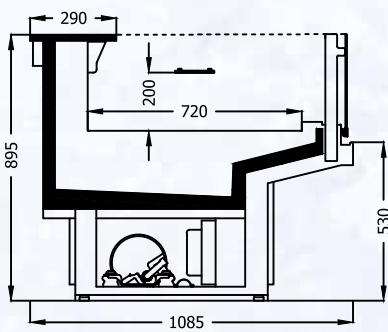

Sparta
85.A1.AK.SS.FG

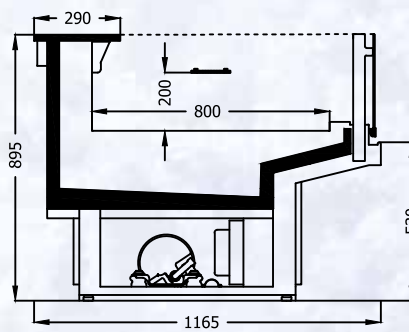

Sparta
95.A1.AK.SS.FG

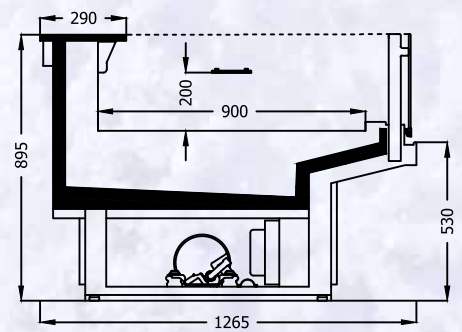

STOW FG

İÇTEN MOTORLU | PLUG - IN



modules 0.938 1.25 1.875 2.500 2.812

Stow 85.A1.AK.FG

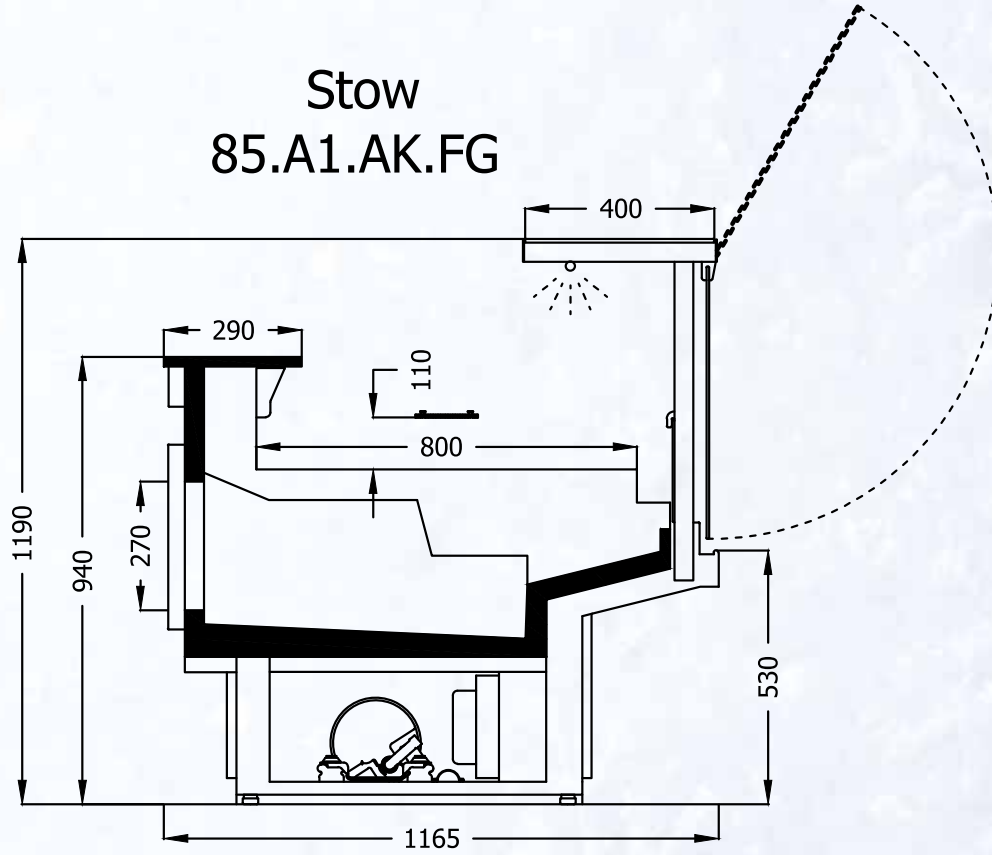

Stow 95.A1.AK.FG

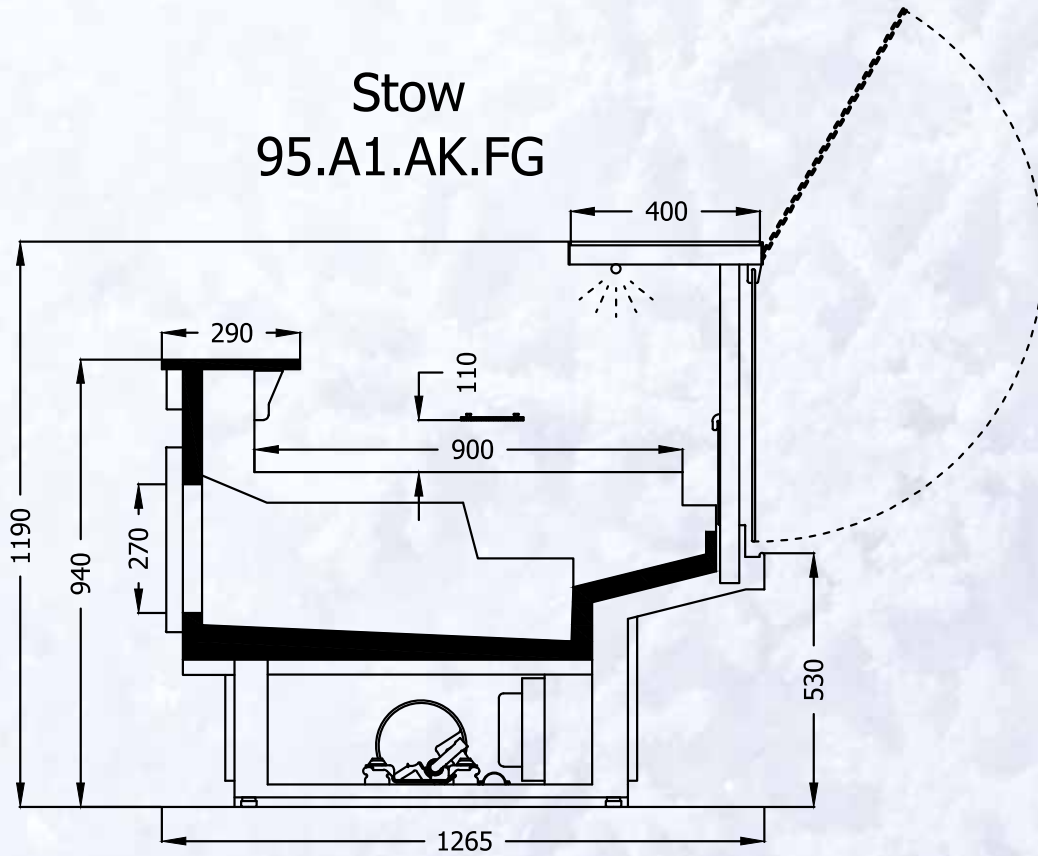

HAWAII

İÇTEN MOTORLU | PLUG - IN

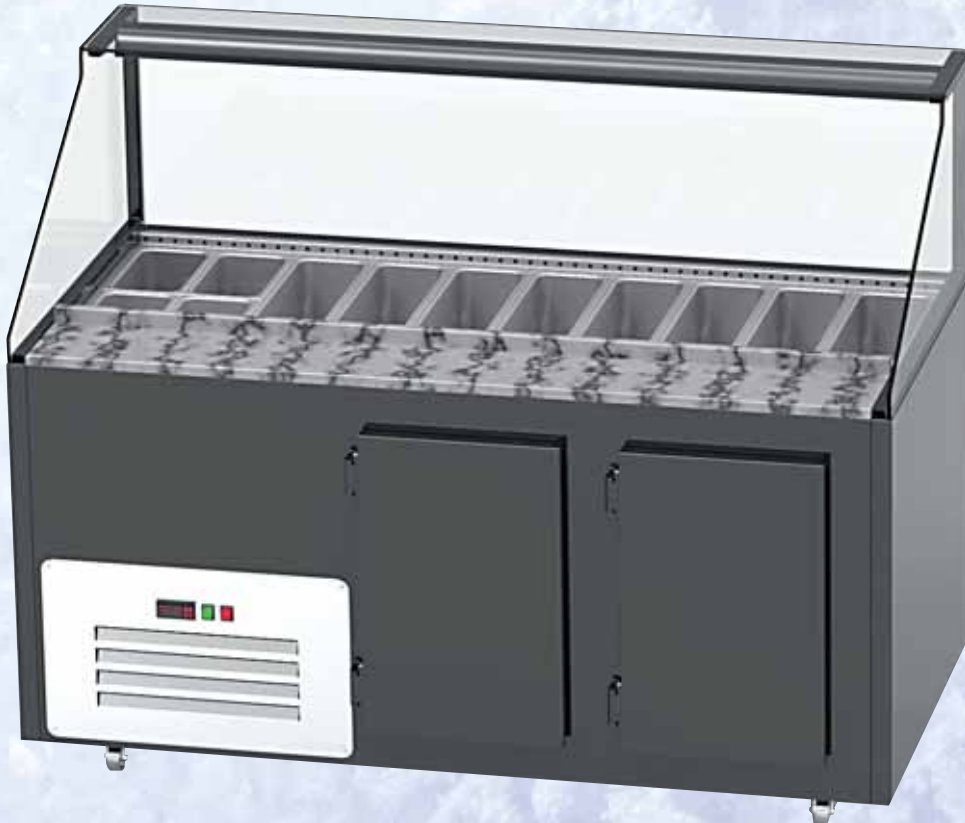

Hawai 850*1300

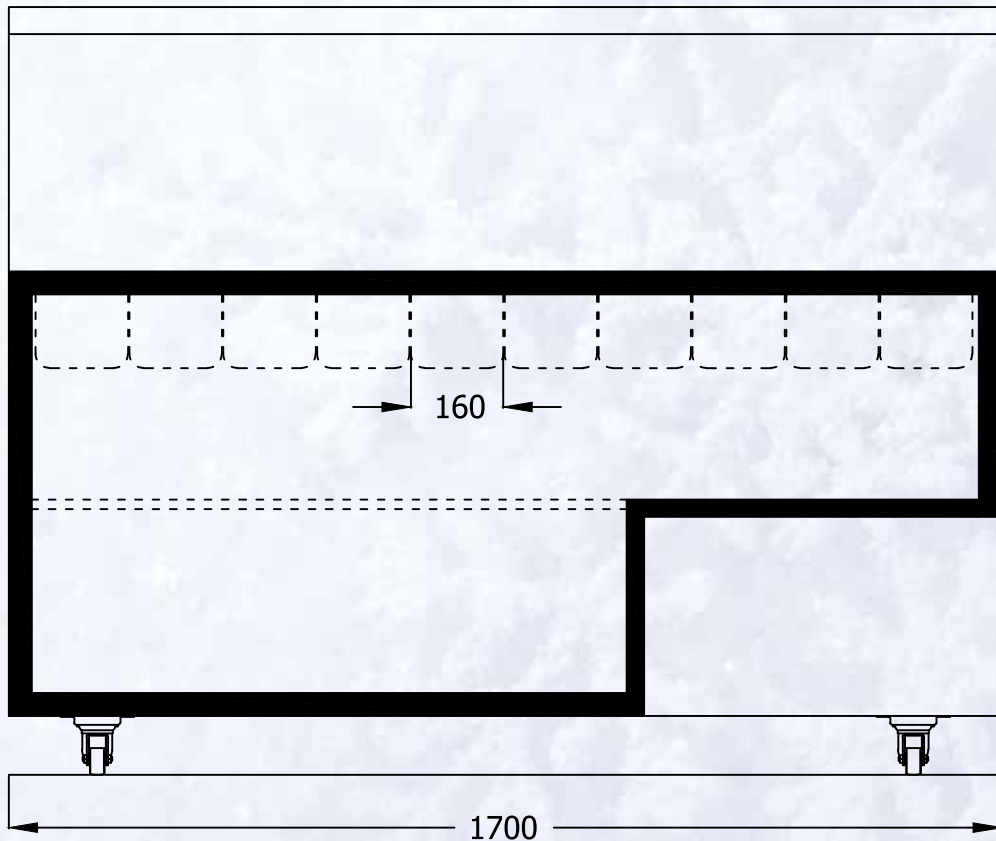
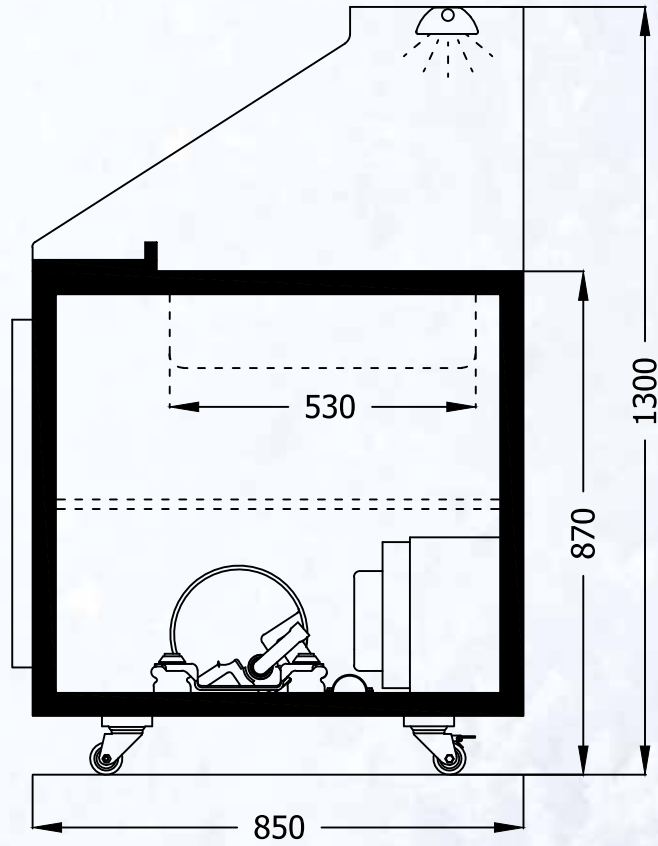

ŞARKÜTERİ | COUNTERS



İÇTEN MOTORLU | PLUG - IN



MANDURAH

İÇTEN MOTORLU | PLUG-IN

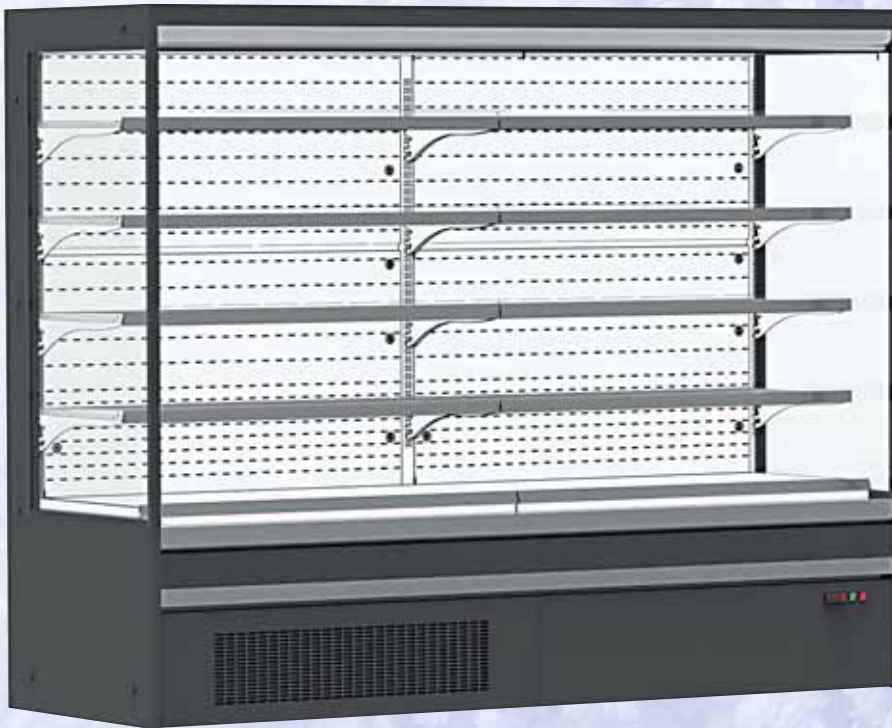
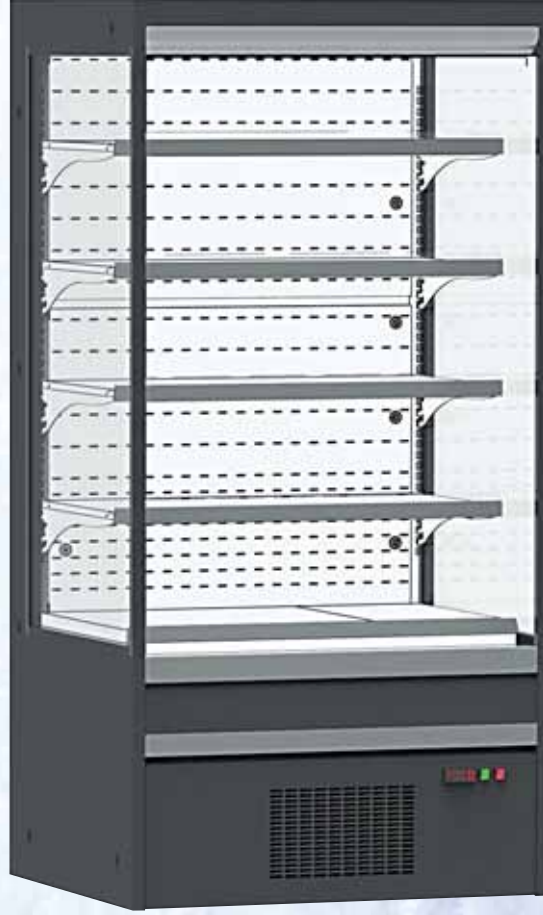

Mandurah
46.A1.L

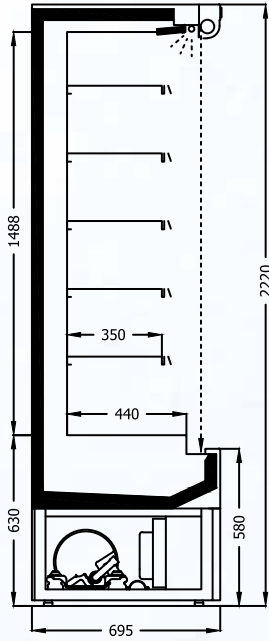

Mandurah
56.A1.L

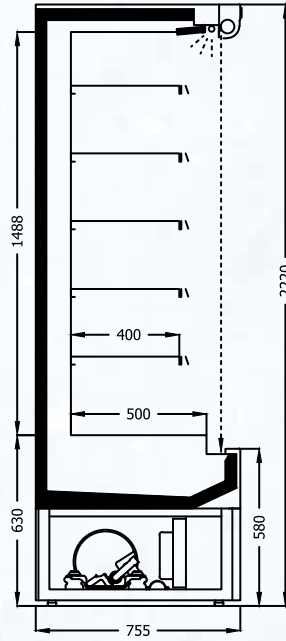

Mandurah
66.A1.L

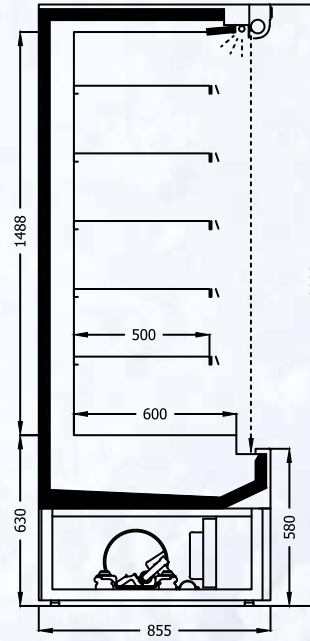

Mandurah
76.A1.L

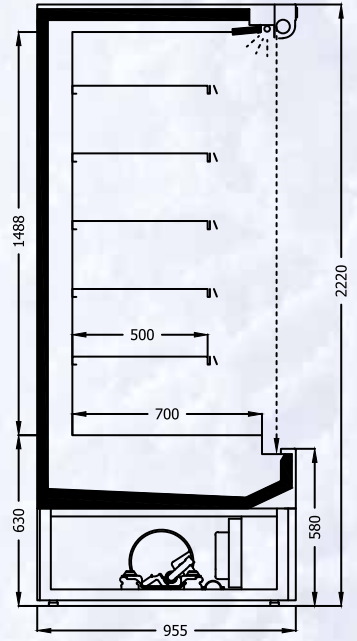

Mandurah
46.A1

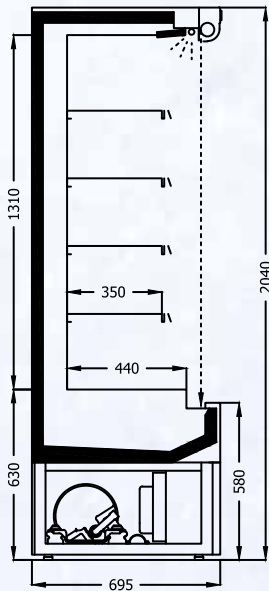

Mandurah
56.A1

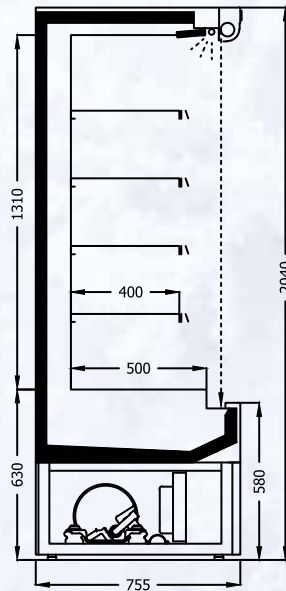

Mandurah
66.A1

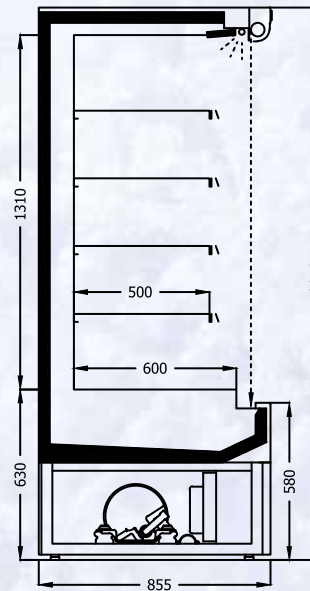

Mandurah
76.A1

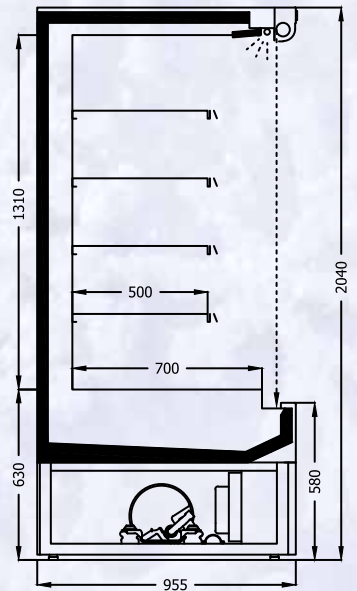

MANDURAH DGD

İÇTEN MOTORLU | PLUG-IN

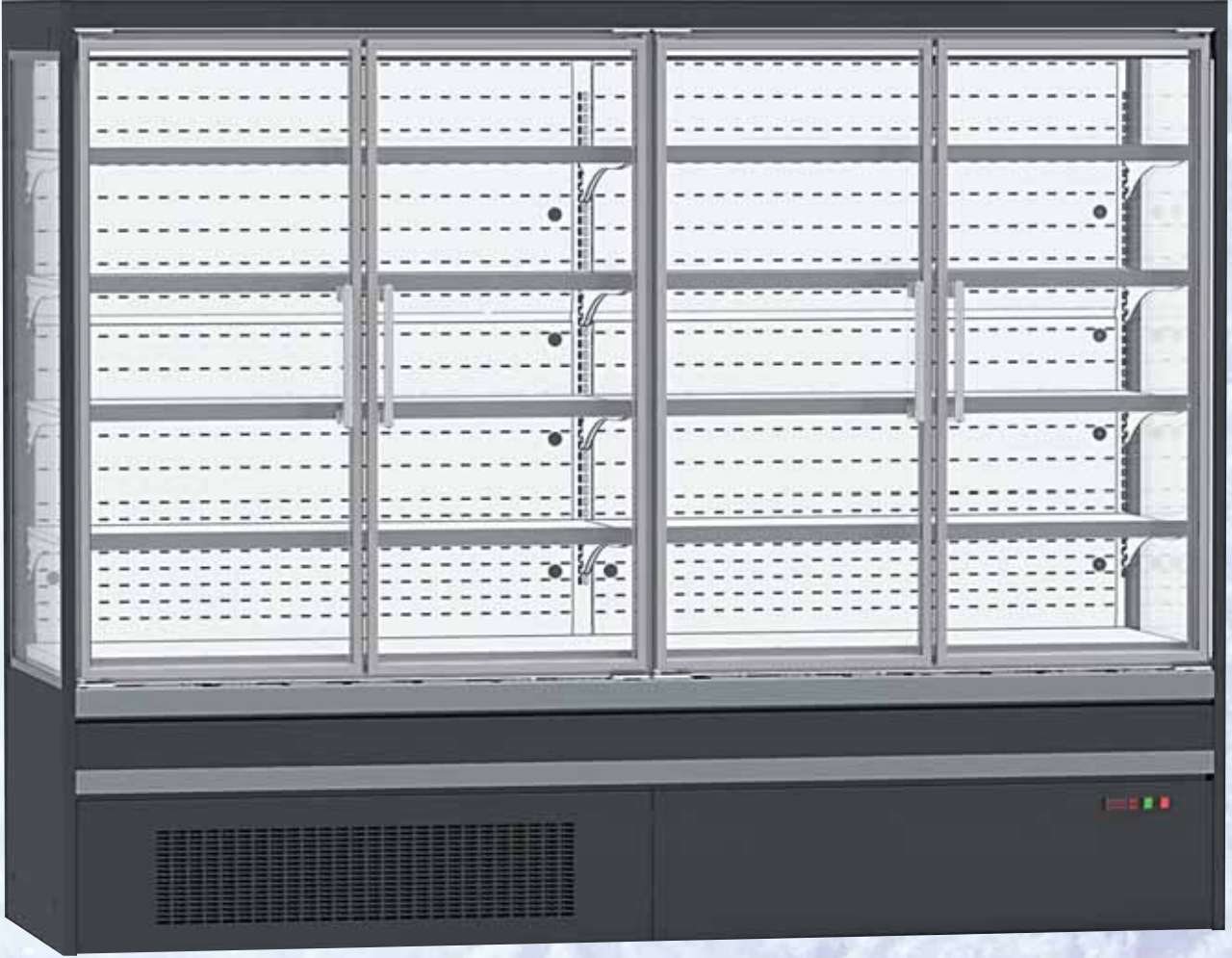

modules 0.938 1.25 1.875 2.500

Mandurah
46.A1.L.DGD

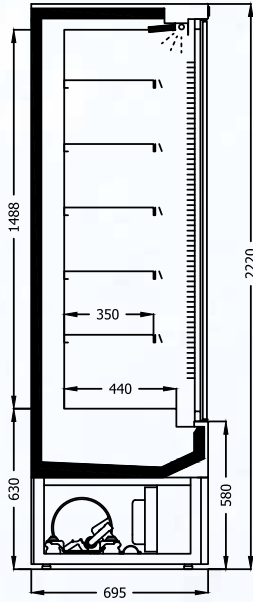

Mandurah
56.A1.L.DGD

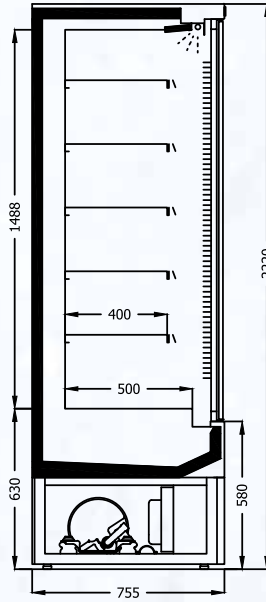

Mandurah
66.A1.L.DGD

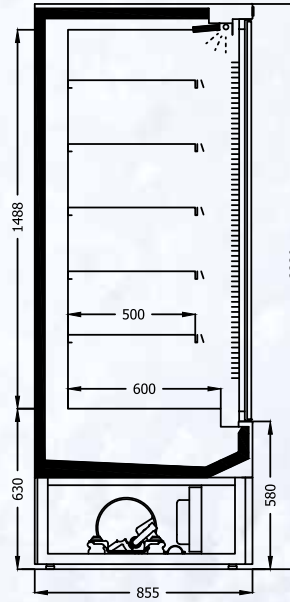

Mandurah
76.A1.L.DGD

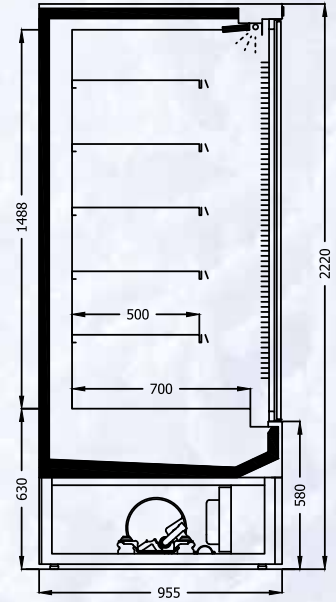

Mandurah
46.A1.DGD

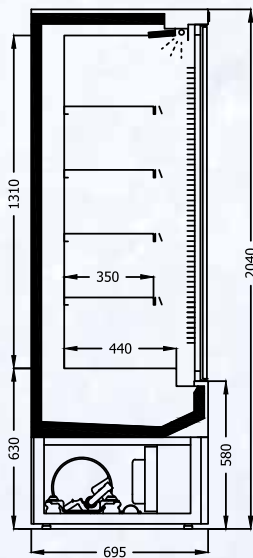

Mandurah
56.A1.DGD

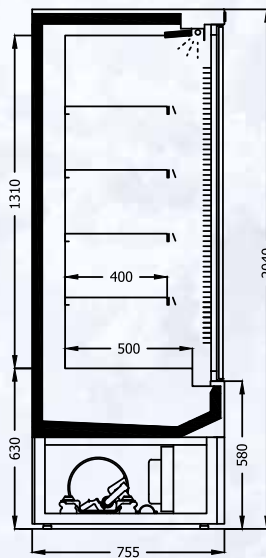

Mandurah
66.A1.DGD

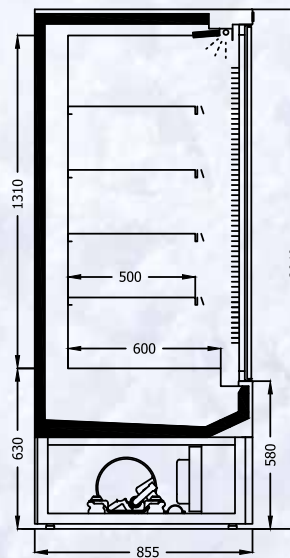

Mandurah
76.A1.DGD

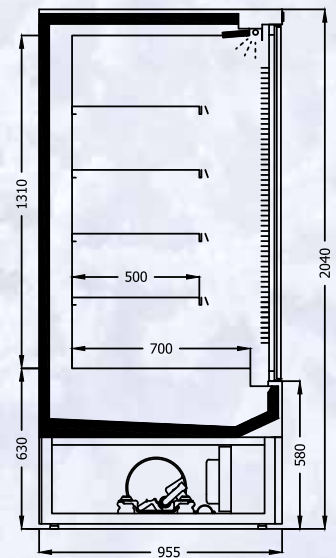

MANDURAH FV

İÇTEN MOTORLU | PLUG - IN

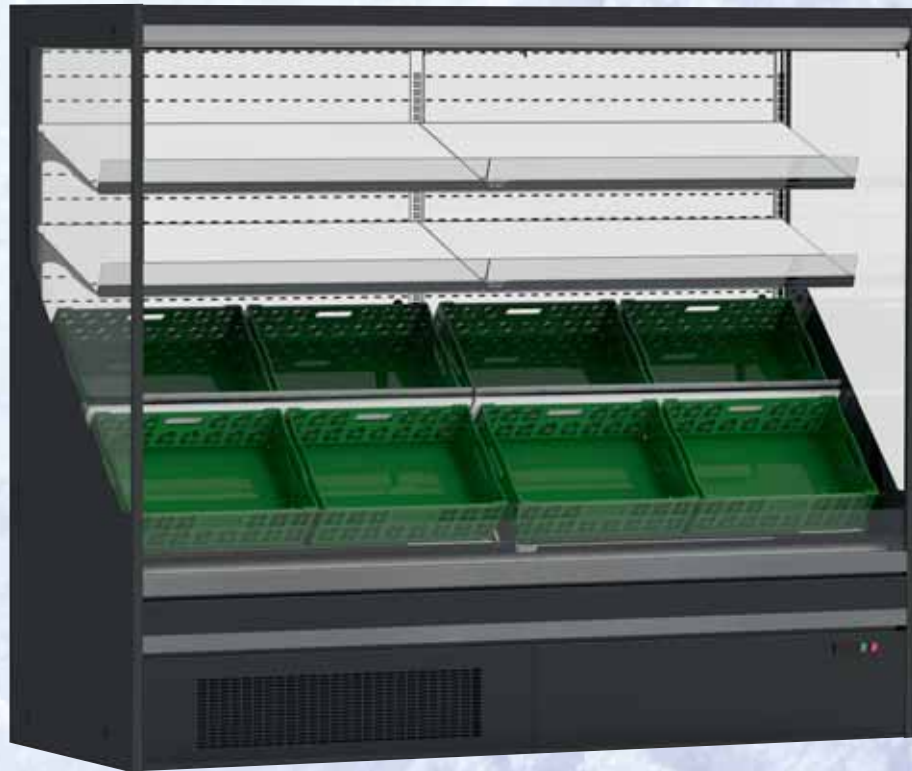

modules 1.25 1.875 2.500

**Mandurah FV
76.A1.L**

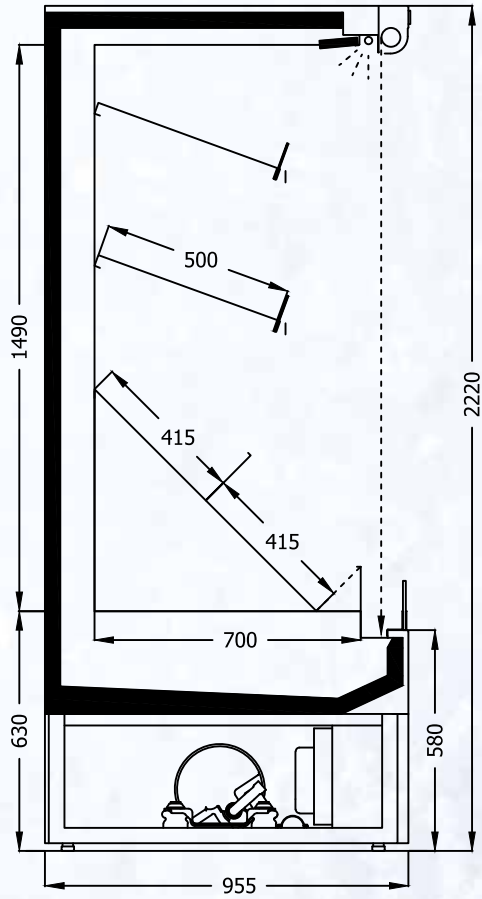

**Mandurah FV
76.A1**

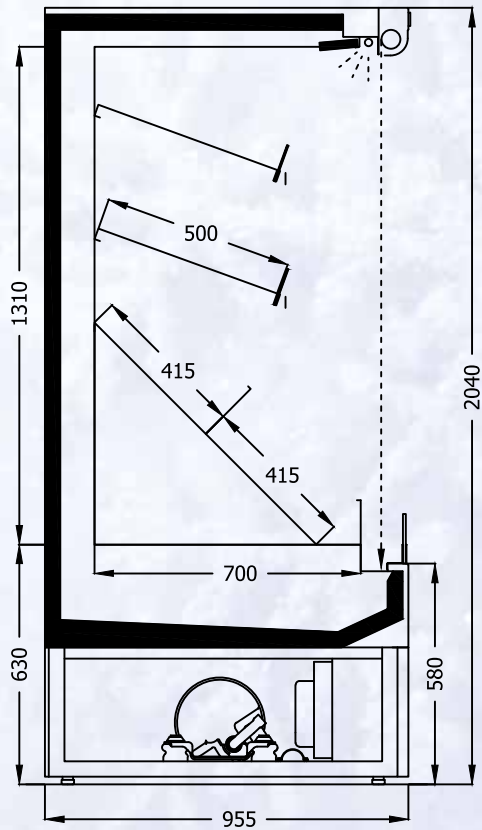

DRY AGED

İÇTEN MOTORLU | PLUG - IN



modules 1.25 1.875 2.500

DRY-AGED 76.A1.L.DGD

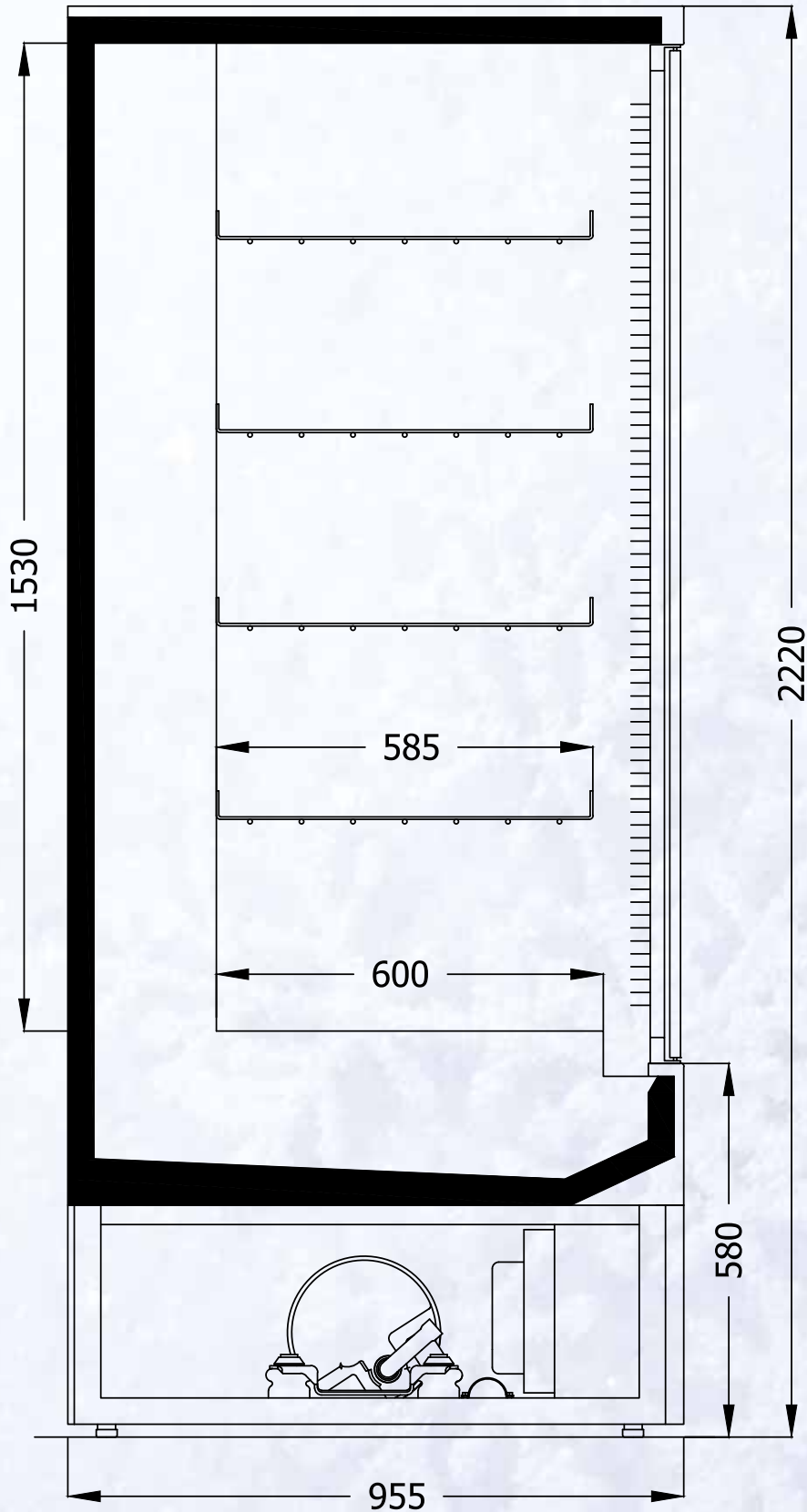

MACON

İÇTEN MOTORLU | PLUG - IN

MACON D-SGD

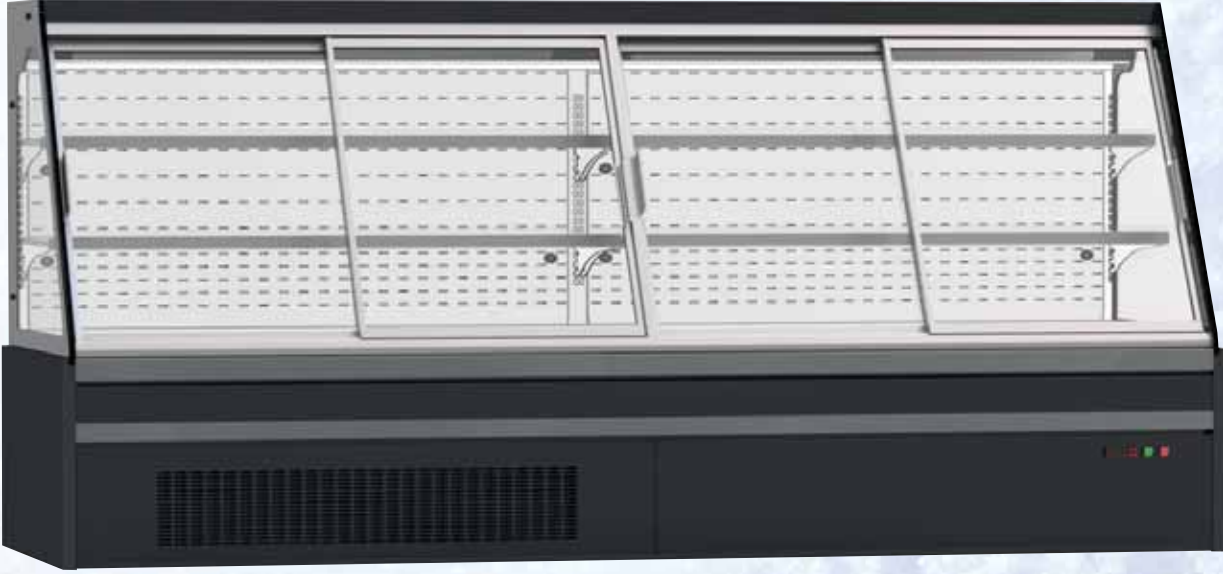

MACON

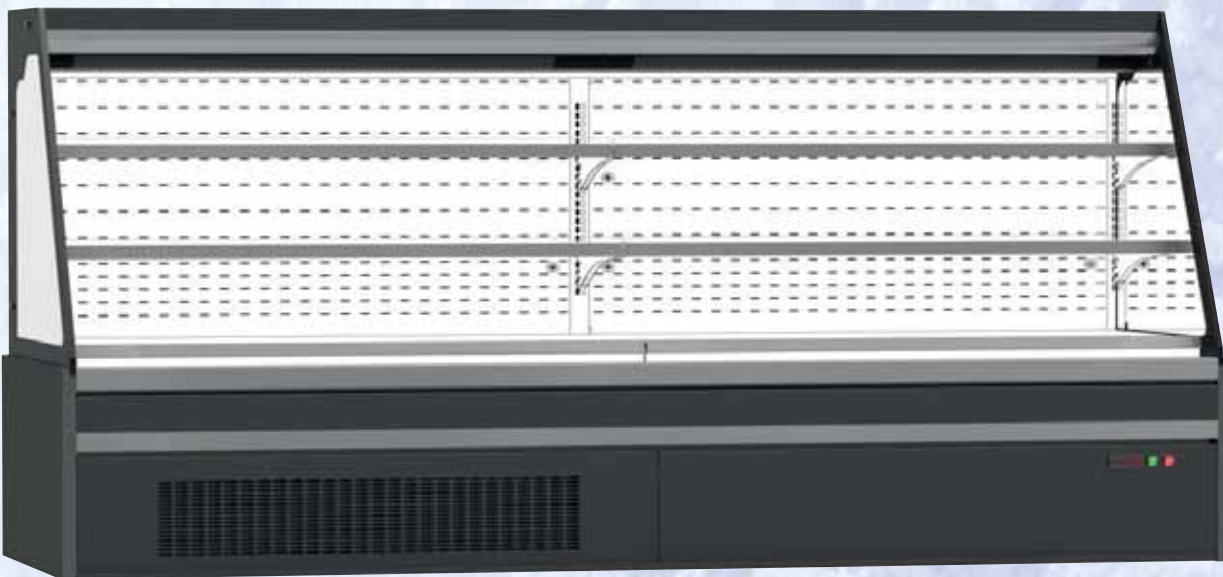

modules 0.938 1.25 1.875 2.500

**Macon
56.A1 H:1550**

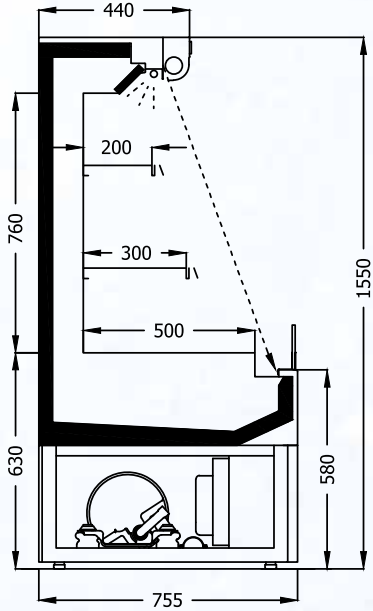

**Macon
66.A1 H:1550**

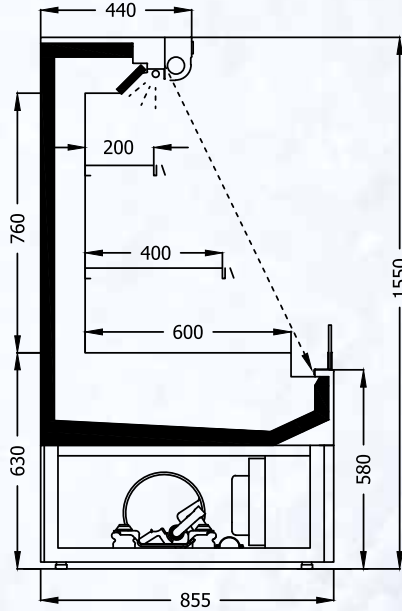

**Macon
76.A1 H:1550**

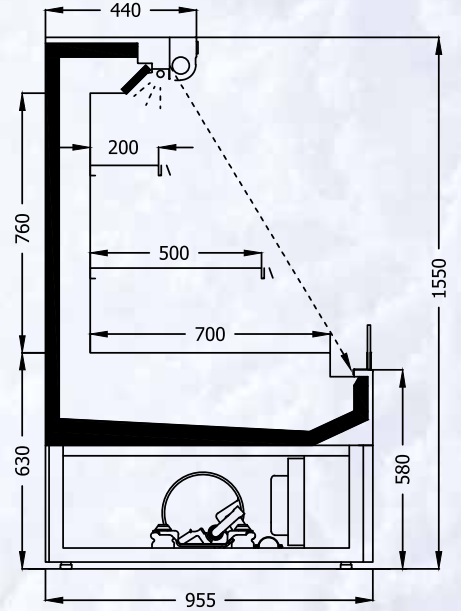

**Macon
56.A1.D-SGD H:1550**

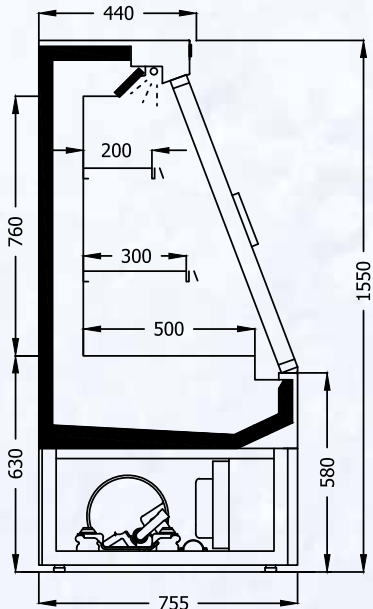

**Macon
66.A1.D-SGD H:1550**

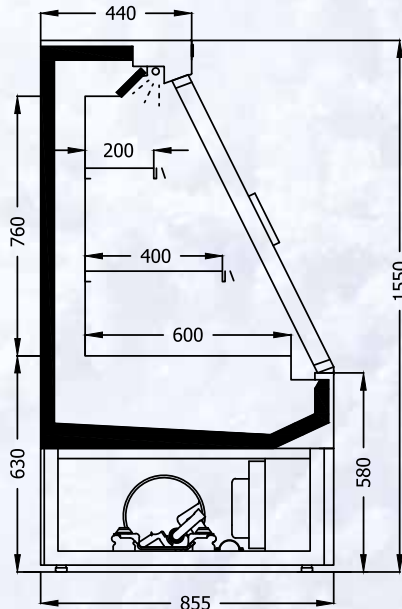

**Macon
76.A1.D-SGD H:1550**

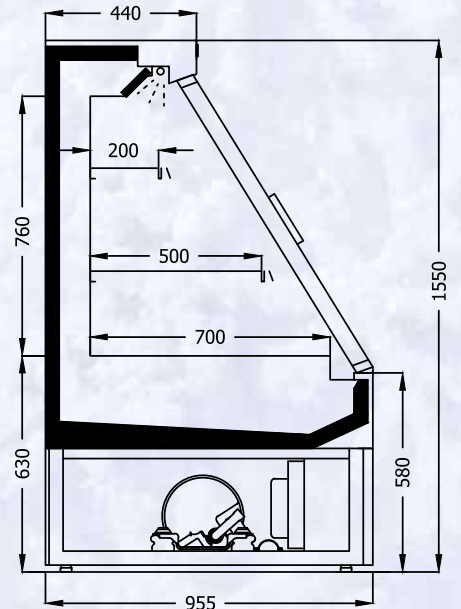

BRISBANE

İÇTEN MOTORLU | PLUG-IN



modules 1.20 2.00

BRISBANE
50.A1

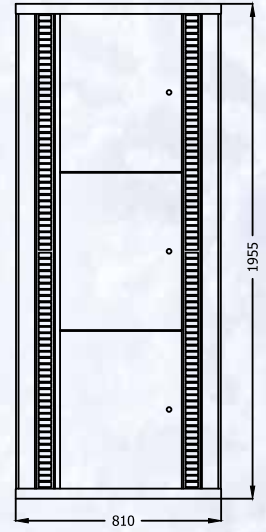
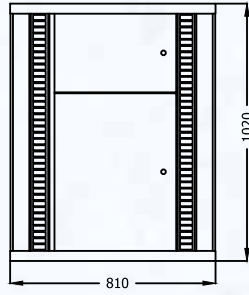
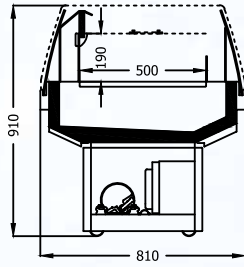

BRISBANE
70.A1

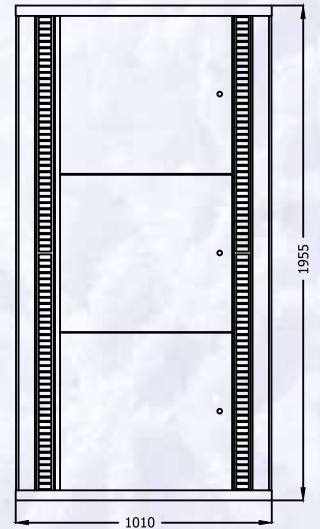
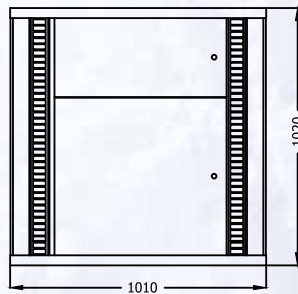
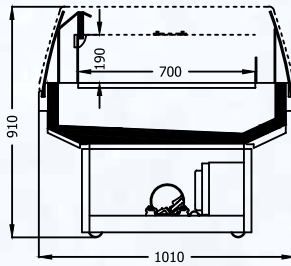

BRISBANE
80.A1

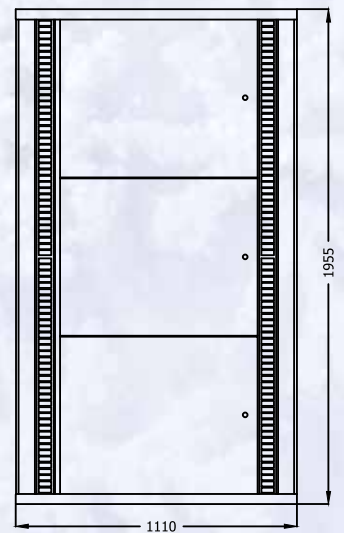
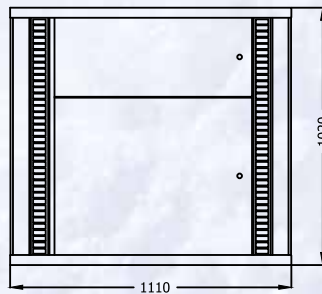
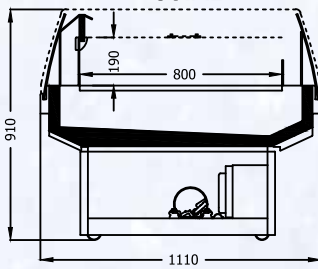

BRISBANE NC. O-SGD

İÇTEN MOTORLU | PLUG - IN



BRISBANE NC



BRISBANE O-SGD

modules 1.20 2.00

**BRISBANE
50.A1.NC**

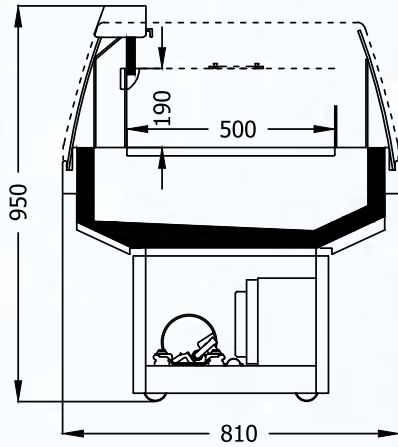

**BRISBANE
50.A1.O-SGD**

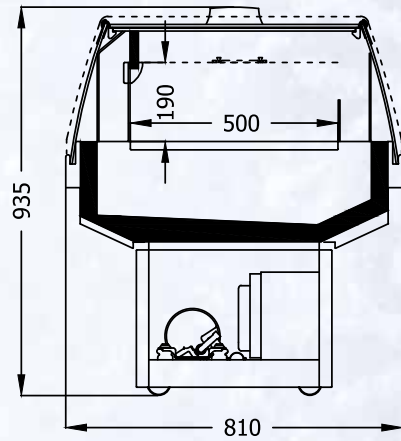

**BRISBANE
70.A1.NC**

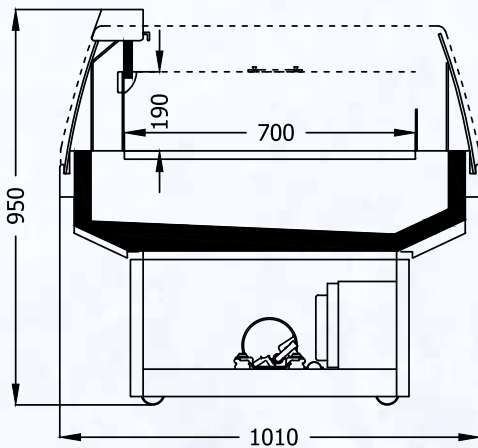

**BRISBANE
70.A1.O-SGD**

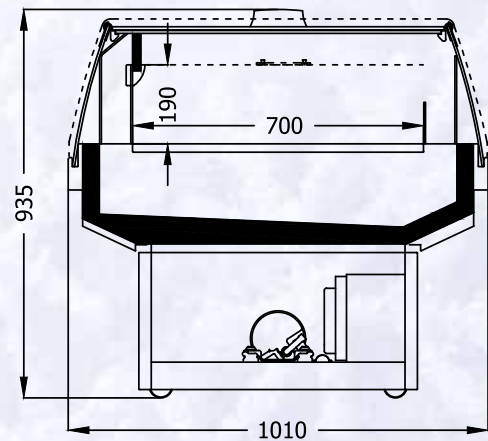

**BRISBANE
80.A1.NC**

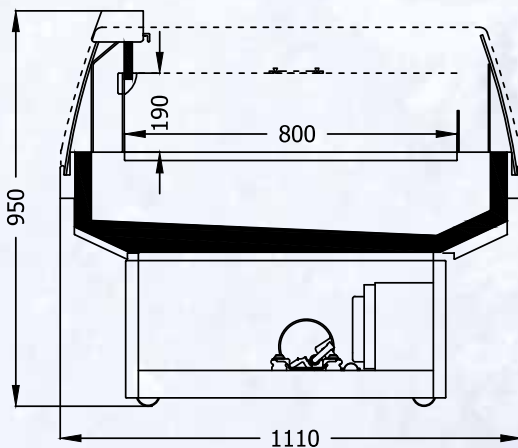

**BRISBANE
80.A1.O-SGD**

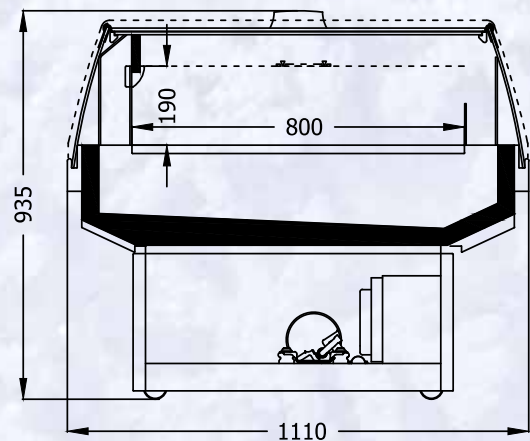

SOĞUK HAVA DEPOLARI

COLD ROOMS



SOĞUTMA SİSTEMLERİ

COOLING SYSTEMS



YETKİLİ SATICI



İNANÇ TEKNİK METAL SAN. ve TİC. LTD. ŞTİ.

Beylikbağı Mah. 326/2 Sk. No:6
41400 Gebze / KOCAELİ
Tel. : 0 262 653 00 33
Faks: 0 262 653 00 31
info@inancteknik.com.tr



www.inancteknik.com.tr



www.kosgeb.gov.tr
Asform Matbaacılık
Kır. Bil. San. Tic. Ltd. Şti.
Tel: 0 262 642 72 75
Basım Tarihi: 02/04/2018
Baskı: 1000 Adet